



PRODUCT OVERVIEW 2019



HENCO PRODUCT OVERVIEW 2019



RADIATOR



SANITARY



FLOOR HEATING

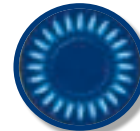

GAS

EN/NL/FR/DE

EN/NL/FR/DE



PRODUCT OVERVIEW 2019

WE CARE TO CONNECT



Pipes		4	1
A. STANDARD (PE-Xc/AL/PE-Xc)		5	
B. RIXc (PE-Xc/AL/PE-Xc)		12	
C. FLOOR-RIXc (PE-Xc/AL/PE-Xc)		15	
D. PE-Xc		16	
E. PE-RT		17	
F. PROTECTION HOSE		18	
G. GAS STANDARD (PE-Xc/AL/PE-Xc)		19	
Henco Press		20	2
A. PK		21	
B. PKW		34	
C. PKG		41	
D. SUPER SIZE		47	
E. HENCO ECOLINE		53	
Henco Vision		54	3
A. SK		55	
B. MANIFOLDS		61	
Brass Press fittings		66	4
A. P		67	
B. PG		81	
Brass Compression fittings		85	5
Manifolds		94	6
Valves		100	7
Underfloor heating		106	8
A. SYSTEMS		107	
B. MANIFOLDS		119	
C. CONTROL UNITS		130	
D. GEOTHERMAL		140	
Cabinets		141	9
Tools		143	10
Accessories		165	11
Certificates		169	



	<i>Page</i>
A. STANDARD (PE-Xc/AL/PE-Xc)	5
B. RIXc (PE-Xc/AL/PE-Xc)	12
C. FLOOR-RIXc (PE-Xc/AL/PE-Xc)	15
D. PE-Xc	16
E. PE-RT	17
F. PROTECTION HOSE	18
G. GAS STANDARD (PE-Xc/AL/PE-Xc)	19

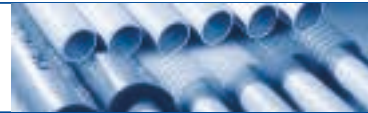

Type: COIL



Henco multilayer pipe (Coil)
 Henco meerlagenbuis (Rol)
 Henco tube multicouche (Rouleau)
 Henco Mehrschichtverbundrohr (Ring)

Article number	m / Pallet	Type
100-121688 **	100 m / 2200 m	12x1,6
200-121688 **	200 m / 3000 m	12x1,6
50-140210 *	50 m / 2000 m	14x2
100-140210	100 m / 2200 m	14x2
200-140210	200 m / 3000 m	14x2
50-160212	50 m / 1500 m	16x2
100-160212	100 m / 2200 m	16x2
200-160212	200 m / 2600 m	16x2
500-160212D	500 m / 2500 m	16x2
100-180214	100 m / 1700 m	18x2
200-180214	200 m / 2000 m	18x2
25-200216	25 m / 800 m	20x2
50-200216	50 m / 1000 m	20x2
100-200216	100 m / 1500 m	20x2
50-260320	50 m / 800 m	26x3
50-320326	50 m / 650 m	32x3

* IDEAL FOR FUEL OIL ** 6 bar - 60°C

Type: COIL CSC



Henco multilayer pipe (Coil Small Core)
 Henco meerlagenbuis (Rol Kleine Kern)
 Henco tube multicouche (Petit Rouleau Noyau intérieure)
 Henco Mehrschichtverbundrohr (Ring kleinen Kern)

Article number	Pallet	Type
10-160212-KB	10 m / 800 m	16x2
15-160212-KB	15 m / 900 m	16x2
25-160212-KB	25 m / 1125 m	16x2
25-200216-KB	25 m / 900 m	20x2

ID Coil: 28cm

A. STANDARD (PE-Xc/AL/PE-Xc)

1 Type: STRAIGHT LENGTH



Henco multilayer pipe (Straight length)

Henco meerlagenbuis (Stang)

Henco tube multicouche (Barre)

Henco Mehrschichtverbundrohr (Stange)

Article number	Cylinder / Pallet	Type
03-160212	75 m / 3600 m	16x2
04-160212	100 m / 4800 m	16x2
05-160212	125 m / 6000 m	16x2
03-180214	60 m 2880 m	18x2
04-180214	80 m / 3840 m	18x2
05-180214	100 m / 4800 m	18x2
03-200216	54 m / 2592 m	20x2
04-200216	72 m / 3456 m	20x2
05-200216	90 m / 4320 m	20x2
03-260320	30 m / 1440 m	26x3
04-260320	40 m / 1920 m	26x3
05-260320	50 m / 2400 m	26x3
03-320326	21 m / 1008 m	32x3
04-320326	28 m / 1344 m	32x3
05-320326	35 m / 1680 m	32x3
03-403533	27 m / 648 m	40x3,5
04-403533	36 m / 864 m	40x3,5
05-403533	45 m / 1080 m	40x3,5
03-504042	21 m / 504 m	50x4
04-504042	28 m / 672 m	50x4
05-504042	35 m / 840 m	50x4
03-634554	12 m / 288 m	63x4,5
04-634554	16 m / 384 m	63x4,5
05-634554	20 m / 480 m	63x4,5
05-756063	10 m / 240 m	75x6
05-907076	5 m / 240 m	90x7

Type: ISO4 (6 mm)



Pre-insulated (Coil)

Voorgeïsoleerd (Rol)

Pré-isolé (Rouleau)

Isoliert (Ring)

Article number	m / Pallet	Type
100-ISO4-14-RO	100 m / 1000 m	14x2 red
100-ISO4-14-BL	100 m / 1000 m	14x2 blue
100-ISO4-16-RO	100 m / 1300 m	16x2 red
100-ISO4-16-BL	100 m / 1300 m	16x2 blue
50-ISO4-18-RO	50 m / 650 m	18x2 red
50-ISO4-18-BL	50 m / 650 m	18x2 blue
50-ISO4-20-RO	50 m / 700 m	20x2 red
50-ISO4-20-BL	50 m / 700 m	20x2 blue
25-ISO4-26-RO	25 m / 300 m	26x3 red
25-ISO4-26-BL	25 m / 300 m	26x3 blue
50-ISO4-26-RO	50 m / 500 m	26x3 red
50-ISO4-26-BL	50 m / 500 m	26x3 blue
25-ISO4-32-RO	25 m / 300 m	32x3 red
25-ISO4-32-BL	25 m / 300 m	32x3 blue

A. STANDARD (PE-Xc/AL/PE-Xc)



Type: ISO9 (10 mm)



Pre-insulated (Coil)
Voorgeïsoleerd (Rol)
Pré-isolé (Rouleau)
Isoliert (Ring)

Article number	m / Pallet	Type
50-ISO9-14-RO	50 m / 550 m	14x2 red
50-ISO9-14-BL	50 m / 550 m	14x2 blue
50-ISO9-16-RO	50 m / 550 m	16x2 red
50-ISO9-16-BL	50 m / 550 m	16x2 blue
50-ISO9-18-RO	50 m / 500 m	18x2 red
50-ISO9-18-BL	50 m / 500 m	18x2 blue
50-ISO9-20-RO	50 m / 500 m	20x2 red
50-ISO9-20-BL	50 m / 500 m	20x2 blue
25-ISO9-26-RO	25 m / 275 m	26x3 red
25-ISO9-26-BL	25 m / 275 m	26x3 blue
50-ISO9-26-RO	50 m / 450 m	26x3 red
50-ISO9-26-BL	50 m / 450 m	26x3 blue
25-ISO9-32-RO	25 m / 250 m	32x3 red
25-ISO9-32-BL	25 m / 250 m	32x3 blue

Type: ISO13 (13 mm)



Pre-insulated (Coil)
Voorgeïsoleerd (Rol)
Pré-isolé (Rouleau)
Isoliert (Ring)

Article number	m / Pallet	Type
50-ISO13-16-BL	50 m / 400 m	16x2 blue
50-ISO13-18-BL	50 m / 400 m	18x2 blue
50-ISO13-20-BL	50 m / 400 m	20x2 blue
50-ISO13-26-BL	50 m / 400 m	26x3 blue
25-ISO13-32-BL	25 m / 200 m	32x3 blue

Type: ISO-EXZ13 (13 mm under, 6 mm above)



Pre-insulated eccentrically, 50% EnEv 2002 (Coil)
Voorgeïsoleerd excentrisch, 50% EnEv 2002 (Rol)
Pré-isolé excentrique (Rouleau)
Isoliert exzentrisch, 50% EnEv 2002 (Ring)

Article number	m / Pallet	Type
50-ISO13-E16-BL	50 m / 500 m	16x2 blue
50-ISO13-E18-BL	50 m / 400 m	18x2 blue
25-ISO13-E20-BL	25 m / 250 m	20x2 blue
25-ISO13-E26-BL	25 m / 225 m	26x3 blue

TILL EXHAUSTION OF STOCK

A. STANDARD (PE-Xc/AL/PE-Xc)

1 Type: ISO-EXZ26 (26 mm under, 6 mm above)



Pre-insulated eccentrically,100% EnEv 2002 (Coil)
Voorgeïsoleerd excentrisch, 100% EnEv 2002 (Rol)
Pré-isolé excentrique(Rouleau)
Isoliert exzentrisch,100% EnEv 2002 (Ring)

Article number	m / Pallet	Type
25-ISO26-E20-BL	25 m / 200 m	20x2 blue
25-ISO26-E26-BL	25 m / 200 m	26x3 blue

TILL EXHAUSTION OF STOCK

7 Type: COMBI ISO



Henco Combi iso 6 mm (Coil)
Henco Combi iso 6mm (Rol)
Henco Combi iso 6mm (Rouleau)
Henco Combi iso 6mm (Ring)

Article number	m / Pallet	Type
■ 50-ISO4-COMBI16	50 m / 400 m	16x2

A. STANDARD (PE-Xc/AL/PE-Xc)



Type: STANDARD PIPE IN PIPE



With colour coded conduit (Coil)

Met mantel (Rol)

Avec gaine (Rouleau)

Mit Mantel (Ring)

Article number	m / Pallet	Type
25-014MR	25 m / 500 m	14x2 red
25-014MB	25 m / 500 m	14x2 blue
50-014MR	50 m / 800 m	14x2 red
50-014MB	50 m / 800 m	14x2 blue
50-014MBLACK	50 m / 800 m	14x2 black
100-014MR	100 m / 1000 m	14x2 red
100-014MB	100 m / 1000 m	14x2 blue
100-014MBLACK	100 m / 1000 m	14x2 black
25-016MR	25 m / 500 m	16x2 red
25-016MB	25 m / 500 m	16x2 blue
50-016MR	50 m / 800 m	16x2 red
50-016MB	50 m / 800 m	16x2 blue
50-016MBLACK	50 m / 800 m	16x2 black
100-016MR	100 m / 1000 m	16x2 red
100-016MB	100 m / 1000 m	16x2 blue
100-016MBLACK	100 m / 1000 m	16x2 black
50-018MR	50 m / 800 m	18x2 red
50-018MB	50 m / 800 m	18x2 blue
100-018MR	100 m / 1000 m	18x2 red
100-018MB	100 m / 1000 m	18x2 blue
25-020MR	25 m / 500 m	20x2 red
25-020MB	25 m / 500 m	20x2 blue
25-020MBLACK	25 m / 500 m	20x2 black
50-020MR	50 m / 800 m	20x2 red
50-020MB	50 m / 800 m	20x2 blue
50-020MBLACK	50 m / 800 m	20x2 black
100-020MB	100 m / 1000 m	20x2 blue
100-020MR	100 m / 1000 m	20x2 red
25-026MR	25 m / 500 m	26x3 red
25-026MB	25 m / 500 m	26x3 blue
50-026MR	50 m / 500 m	26x3 red
50-026MB	50 m / 500 m	26x3 blue
50-026MBLACK	50 m / 500 m	26x3 black
25-032MR	25 m / 300 m	32x3 red
25-032MB	25 m / 300 m	32x3 blue

Type: COMBI STANDARD



Henco Combi (Coil)

Henco Combi (Rol)

Henco Combi (Rouleau)

Henco Combi (Ring)

Article number	m / Pallet	Type
50-COMBI16	50 m / 800 m	16x2

A. STANDARD (PE-Xc/AL/PE-Xc)

1 Type: FLEX STANDARD



Henco Flex (Coil)
Henco Flex (Rol)
Henco Flex (Rouleau)
Henco Flex (Ring)

Article number	Packing	Type
100-FLEX26	100 m	2 - 26x3 (OD90)
100-FLEX32	100 m	2 - 32x3 (OD125)

TILL EXHAUSTION OF STOCK

8 Type: STANDARD PIPE IN PIPE CSC



With colour coded conduit (Coil Small Core)
Met mantel (Rol Kleine Kern)
Avec gaine (Petit Rouleau Noyau intérieure)
Mit Mantel (Ring kleinen Kern)

Article number	Pallet	Type
25-016MB-KB	25 m / 600 m	16x2
25-016MR-KB	25 m / 600 m	16x2

ID Coil: 28cm

Type: LB



Henco carcassing pipe Ø 16
Dubbele radiatorbocht Henco buis Ø 16, doorverbonden einde
Double courbe radiateur, tube Henco Ø 16, embout fermé
Heizkörperwinkel doppelt, Henco Rohr Ø 16, durchgestellt Ende

Article number	m	Type
LB50	1 m	50 mm

Type: ISO-BLOCK-S



Henco carcassing pipe Ø 16 with insulation
Dubbele radiatoraansluitbocht met isolatie, Ø 16, doorverbonden einde
Double courbe radiateur, Ø 16, avec isolation, embout fermé
Heizkörperwinkel doppelt mit Isolation, Ø 16, durchgestellt Ende

Article number	m	Type
ISO-BLOCK-S	1 m	ISO-BLOCK-S

TILL EXHAUSTION OF STOCK



Type: ISO-BLOCK-L



Henco carcassing pipe Ø 16 with insulation
 Dubbele radiatoraansluitbocht met isolatie, Ø 16, doorverbonden einde
 Double courbe radiateur, Ø 16, avec isolation, embout fermé
 Heizkörperwinkel doppelt mit Isolation, Ø 16, durchgestellt Ende

Article number	m	Type
ISO-BLOCK-L	1 m	ISO-BLOCK-L

Type: ISO-BLOCK-XL



Henco carcassing pipe Ø 16 with insulation
 Dubbele radiatoraansluitbocht met isolatie, Ø 16, doorverbonden einde
 Double courbe radiateur, Ø 16, avec isolation, embout fermé
 Heizkörperwinkel doppelt mit Isolation, Ø 16, durchgestellt Ende

Article number	m	Type
ISO-BLOCK-XL	1 m	ISO-BLOCK-XL

1

2

3

4

5

6

7

8

9

10

11

B. RIXc (PE-Xc/AL/PE-Xc)

1 Type: COIL



Henco multilayer pipe RIXc (Coil)
 Henco meerlagenbuis RIXc (Rol)
 Henco tube multicouche RIXc (Rouleau)
 Henco Merschichtverbundrohr RIXc (Ring)

Article number	m / Pallet	Type
50-R160212	50 m / 1500 m	16x2
100-R160212	100 m / 2200 m	16x2
200-R160212	200 m / 2600 m	16x2
500-R160212D	500 m / 2500 m	16x2
100-R180214	100 m / 1700 m	18x2
200-R180214	200 m / 2000 m	18x2
100-R200216	100 m / 1500 m	20x2
50-R260320	50 m / 800 m	26x3

2 Type: COIL CSC



Henco multilayer pipe RIXc (Coil Small Core)
 Henco meerlagenbuis RIXc (Rol Kleine Kern)
 Henco tube multicouche RIXc (Rouleau Petit Noyau)
 Henco Merschichtverbundrohr RIXc (Ring kleinen Kern)

Article number	Pallet	Type
10-R160212-KB	10 m / 800 m	16x2
15-R160212-KB	15 m / 900 m	16x2
25-R160212-KB	25 m / 1125 m	16x2

ID Coil: 28cm

3 Type: STRAIGHT LENGTH



Henco multilayer pipe RIXc (Straight length)
 Henco meerlagenbuis RIXc (Stang)
 Henco tube multicouche RIXc (Barre)
 Henco Merschichtverbundrohr RIXc (Stange)

Article number	Cylinder	Type
03-R160212	75 m / 3600 m	16x2
04-R160212	100 m / 4800 m	16x2
05-R160212	125 m / 6000 m	16x2
03-R200216	54 m / 2592 m	20x2
04-R200216	72 m / 3456 m	20x2
05-R200216	90 m / 4320 m	20x2
03-R260320	30 m / 1440 m	26x3
04-R260320	40 m / 1920 m	26x3
05-R260320	50 m / 2400 m	26x3

B. RIXc (PE-Xc/AL/PE-Xc)



Type: ISO4 (6 mm)



RIXc Pre-insulated (Coil)
 RIXc Voorgeïsoleerd (Rol)
 RIXc Pré-isolé (Rouleau)
 RIXc Isoliert (Ring)

Article number	m / Pallet	Typ
100-ISO4-R16-RO	100 m / 1300 m	16x2 red
100-ISO4-R16-BL	100 m / 1300 m	16x2 blue
50-ISO4-R18-RO	50 m / 650 m	18x2 red
50-ISO4-R18-BL	50 m / 650 m	18x2 blue
50-ISO4-R20-RO	50 m / 700 m	20x2 red
50-ISO4-R20-BL	50 m / 700 m	20x2 blue
25-ISO4-R26-RO	25 m / 300 m	26x3 red
25-ISO4-R26-BL	25 m / 300 m	26x3 blue
50-ISO4-R26-RO	50 m / 500 m	26x3 red
50-ISO4-R26-BL	50 m / 500 m	26x3 blue

Type: ISO9 (10 mm)



RIXc Pre-insulated (Coil)
 RIXc Voorgeïsoleerd (Rol)
 RIXc Pré-isolé (Rouleau)
 RIXc Isoliert (Ring)

Article number	m / Pallet	Typ
50-ISO9-R16-RO	50 m / 550 m	16x2 red
50-ISO9-R16-BL	50 m / 550 m	16x2 blue
50-ISO9-R18-BL	50 m / 650 m	18x2 blue
50-ISO9-R20-RO	50 m / 500 m	20x2 red
50-ISO9-R20-BL	50 m / 500 m	20x2 blue
25-ISO9-R26-RO	25 m / 275 m	26x3 red
25-ISO9-R26-BL	25 m / 275 m	26x3 blue

Type: ISO13 (13 mm)



RIXc Pre-insulated (Coil)
 RIXc Voorgeïsoleerd (Rol)
 RIXc Pré-isolé (Rouleau)
 RIXc Isoliert (Ring)

Article number	m / Pallet	Typ
50-ISO13-R16-BL	50 m / 500 m	16x2 blue
50-ISO13-R20-BL	50 m / 400 m	20x2 blue
50-ISO13-R26-BL	50 m / 400 m	26x3 blue

- 1
- 2
- 3
- 4
- 5
- 6
- 7
- 8
- 9
- 10
- 11

B. RIXc (PE-Xc/AL/PE-Xc)

1 Type: COMBI ISO RIXc



Henco Combi iso 6 mm (Coil)
 Henco Combi iso 6mm (Rol)
 Henco Combi iso 6mm (Rouleau)
 Henco Combi iso 6mm (Ring)

Article number	m / Pallet	Type
■ 50-ISO4-COMBI16R	50 m / 400 m	16x2

7 Type: RIXc PIPE IN PIPE



RIXc With colour coded conduit (Coil)
 RIXc Met mantel (Rol)
 RIXc Avec gaine (Rouleau)
 RIXc Mit Mantel (Ring)

Article number	m / Pallet	Type
25-R16MR	25 m / 500 m	16x2 red
25-R16MB	25 m / 500 m	16x2 blue
50-R16MR	50 m / 1000 m	16x2 red
50-R16MB	50 m / 1000 m	16x2 blue
50-R16MBLACK	50 m / 1000 m	16x2 black
100-R16MR	100 m / 1000 m	16x2 red
100-R16MB	100 m / 1000 m	16x2 blue
100-R16MBLACK	100 m / 1000 m	16x2 black
50-R18MR	50 m / 800 m	18x2 red
50-R18MB	50 m / 800 m	18x2 blue
25-R20MR	25 m / 500 m	20x2 red
25-R20MB	25 m / 500 m	20x2 blue
25-R20MBLACK	25 m / 500 m	20x2 black
50-R20MR	50 m / 800 m	20x2 red
50-R20MB	50 m / 800 m	20x2 blue
100-R20MR	100 m / 1000 m	20x2 red
100-R20MB	100 m / 1000 m	20x2 blue
50-R26MR	50 m / 500 m	26x3 red
50-R26MB	50 m / 500 m	26x3 blue

Type: COMBI RIXc



Henco Combi (Coil)
 Henco Combi (Rol)
 Henco Combi (Rouleau)
 Henco Combi (Ring)

Article number	m / Pallet	Type
50-COMBI16R	50 m / 800 m	16x2



Type: FLOOR-RIXc



Henco multilayer pipe (Coil)

Henco meerlagenbuis (Rol)

Henco tube multicouche (Rouleau)

Henco Mehrschichtverbundrohr (Ring)

Article number	m / Pallet	Type
100-F16R-WZ	100 m / 2200 m	16x2
200-F16R-WZ	200 m / 2600 m	16x2
500-F16R-WZ	500 m / 2500 m	16x2
100-F20R-WZ	100 m / 1000 m	20x2
200-F20R-WZ	200 m / 1000 m	20x2
400-F20R-WZ	400 m / 1200 m	20x2

6 bar - 60°C

1

2

3

4

5

6

7

8

9

10

11

Type: 5L PE-Xc



Henco 5L PE-Xc pipe PE-Xc/EVOH/PE-Xc (Coil)

Henco 5L PE-Xc buis PE-Xc/EVOH/PE-Xc (Rol)

Henco 5L PE-Xc tube PE-Xc/EVOH/PE-Xc (Rouleau)

Henco 5L PE-Xc Rohr PE-Xc/EVOH/PE-Xc (Ring)

Article number	m / Pallet	Type
200-PXC1620	200 m / 1600 m	16x2
600-PXC1620	600 m / 2400 m	16x2
200-PXC1720	200 m / 2000 m	17x2
600-PXC1720	600 m / 2400 m	17x2
240-PXC1820	240 m / 2160 m	18x2
200-PXC2020	200 m / 1000 m	20x2
600-PXC2020	600 m / 1200 m	20x2



Type: 5L PE-RT



Henco 5L PE-RT pipe PE-RT/EVOH/PE-RT (Coil)

Henco 5L PE-RT buis PE-RT/EVOH/PE-RT (Rol)

Henco 5L PE-RT tube PE-RT/EVOH/PE-RT (Rouleau)

Henco 5L PE-RT Rohr PE-RT/EVOH/PE-RT (Ring)

Article number	m / Pallet	Type
120-PRT1620	120 m / 1440 m	16x2
200-PRT1620	200 m / 1600 m	16x2
600-PRT1620	600 m / 2400 m	16x2
600-PRT1720	600 m / 2400 m	17x2
600-PRT1820	600 m / 1200 m	18x2
600-PRT2020	600 m / 1800 m	20x2

1

2

3

4

5

6

7

8

9

10

11

F. PROTECTION HOSE

1 Type: PROTECTION HOSE



Colour coded conduit (Coil)

Mantel (Rol)

Gainé (Rouleau)

Mantel (Ring)

Article number	m / Pallet	Type
100-MR	100 m / 2400 m	Ø14/Ø16/Ø18
100-MB	100 m / 2400 m	Ø14/Ø16/Ø18 blue
50-MR20	50 m / 1800 m	Ø20 red
50-MB20	50 m / 1800 m	Ø20 blue
50-MR26	50 m / 1200 m	Ø26 red
50-MB26	50 m / 1200 m	Ø26 blue
25-MR32	25 m / 1000 m	Ø32 red
25-MB32	25 m / 1000 m	Ø32 blue
100-MBLACK	100 m / 2400 m	Ø14/Ø16/Ø18 black
50-MBLACK20	50 m / 1800 m	Ø20 black
50-MBLACK26	50 m / 1200 m	Ø26 black

11 Type: PROTECTION HOSE GAS



Colour coded conduit (Coil)

Mantel (Rol)

Gainé (Rouleau)

Mantel (Ring)

Article number	m / Pallet	Type
50-MG16	50 m / 2400 m	Ø16 yellow
100-MG16	100 m / 2400 m	Ø16 yellow
50-MG20	50 m / 1800 m	Ø20 yellow
50-MG26	50 m / 1200 m	Ø26 yellow
25-MG32	25 m / 1000 m	Ø32 yellow

G. GAS STANDARD (PE-Xc/AL/PE-Xc)



Gas: only allowed in countries where has been a HENCO GAS testing + certificate is available! (see www.henco.be)
Gas: enkel toegelaten in landen waar er een HENCO GAS keur is + een certificaat voorhanden is! (zie www.henco.be)
Gaz: seulement permis dans des pays où le contrôle a eu lieu + certificat est disponible! (Consultez www.henco.be)
Gas: nur zugelassen in Länder wo HENCO GAS Prüfung geschehen ist + Zertifikat vorhanden ist! (Siehe www.henco.be)

Type: COIL



Henco multilayer pipe (Coil)
 Henco Meerlagenbuis (Rol)
 Henco tube multicouche (Rouleau)
 Henco Mehrschichtverbundrohr (Ring)

Article number	m / Pallet	Type
25-160212-GAS	25 m / 800 m	16x2
50-160212-GAS	50 m / 1500 m	16x2
25-200216-GAS	25 m / 800 m	20x2
50-200216-GAS	50 m / 1000 m	20x2
50-260320-GAS	50 m / 800 m	26x3
50-320326-GAS	50 m / 650 m	32x3

Type: STRAIGHT LENGTH



Henco multilayer pipe (Straight length)
 Henco Meerlagenbuis (Stang)
 Henco tube multicouche (Barre)
 Henco Mehrschichtverbundrohr (Stange)

Article number	Cylinder / Pallet	Type
05-160212-GAS	125 m / 6000 m	16x2
05-200216-GAS	90 m / 4300 m	20x2
05-260320-GAS	50 m / 2400 m	26x3
05-320326-GAS	35 m / 1680 m	32x3
05-403533-GAS	45 m / 1080 m	40x3,5

Type: GAS PIPE IN PIPE



With colour coded conduit (Coil)
 Met mantel (Rol)
 Avec gaine (Rouleau)
 Mit Mantel (Ring)

Article number	m / Pallet	Typ
25-016GASMG	25 m / 500 m	16x2
50-016GASMG	50 m / 500 m	16x2
25-020GASMG	25 m / 500 m	20x2
50-020GASMG	50 m / 800 m	20x2
50-026GASMG	50 m / 500 m	26x3
25-032GASMG	25 m / 300 m	32x3

Gastec: Standard pipe gas in combination with Henco press fittings PVDF for gas, see page 41

DVGW and Kiwa Uni: Standard pipe gas in combination with Henco brass press fittings for gas, see page 81





	<i>Page</i>
A. PK	21
B. PKW	34
C. PKG	41
D. SUPER SIZES	47
E. ECOLINE	53



Type: 1PK



Elbow 90°
Knie 90°
Coude 90°
Winkel 90°

Article number	Bag / Box	Type
1PK-1414	10 pc. / 150 pc.	14x14
1PK-1616	10 pc. / 120 pc.	16x16
1PK-1818	10 pc. / 100 pc.	18x18
1PK-2020	10 pc. / 80 pc.	20x20
1PK-2626	5 pc. / 50 pc.	26x26
1PK-3232	5 pc. / 30 pc.	32x32
1PK-4040	5 pc. / 20 pc.	40x40
1PK-5050	1 pc. / 8 pc.	50x50
1PK-6363	1 pc. / 6 pc.	63x63
1PK-7575	See page 47	75x75
1PK-9090	See page 47	90x90
1PK-9075	See page 47	90x75

Type: 1PK-JG



Elbow 90° 16x10JG (ceiling cooling)
Knie 90° 16x10JG (koelplafond)
Coude 90° 16x10JG (plafond climatisé)
Winkel 90° 16x10JG (Klimaatplafond)

Article number	Bag / Box	Type
1PK-16JG10	10 pc. / 120 pc.	16x10JG
1PK-20JG10	10 pc. / 100 pc.	20x10JG

Type: 2PK



Backplate elbow female
Sanitair muurplaat binnendraad
Culasse pour sanitaire
Sanitär Wandscheibe IG

Article number	Bag / Box	Type
2PK-1404BP*	10 pc. / 50 pc.	14x1/2" (56 mm)
2PK-1603	10 pc. / 50 pc.	16x3/8" (56 mm)
2PK-1604BP*	10 pc. / 50 pc.	16x1/2" (56 mm)
2PK-1804BP*	10 pc. / 50 pc.	18x1/2" (56 mm)
2PK-2004BP*	10 pc. / 50 pc.	20x1/2" (56 mm)
2PK-2005	5 pc. / 30 pc.	20x3/4" (56 mm)
2PK-2605	5 pc. / 30 pc.	26x3/4" (56 mm)

* With black plug BP04 1/2"

Accessory 2PK: galvanised bracket plate - see page 168



PLP-P-PK



PLF-P-PK

Type: 2PK-K



Backplate elbow female, short model
 Sanitair muurplaat binnendraad, laag
 Culasse pour sanitaire, modèle court
 Sanitär Wandscheibe IG, kurzes Modell

Article number	Bag / Box	Type
2PK-1604KBP*	10 pc. / 50 pc.	16x1/2" (40 mm)

* With black plug BP04 1/2"

Accessory 2PK-K: galvanised bracket plate - see page 168



PLP-P-PK



PLF-P-PK

Type: 3PK



Double backplate elbow female, short model
 Sanitair muurplaat binnendraad dubbel, laag
 Culasse double pour sanitaire, modèle court
 Sanitär Wandscheibe doppelt IG, kurzes Modell

Article number	Bag / Box	Type
3PK-160416BP*	10 pc. / 30 pc.	16x1/2"x16 (40 mm)
3PK-200420BP*	10 pc. / 30 pc.	20x1/2"x20 (40 mm)

* With black plug BP04 1/2"

Type: BP04



Black plug for 1/2" female nipple
 Zwarte stop voor 1/2"
 Bouchon noir pour 1/2" nipple femelle
 Schwarzen Stopf für 1/2" Nippel

Article number	Bag / Box	Type
BP04	50 pc. / 500 pc.	1/2"



Type: 5PK (CW617)



PK-TOOL p 164

Bend 90° male adapter
Knie 90° buitendraad
Coude 90° mâle
Winkel 90° AG

Article number	Bag / Box	Type
5PK-1404	10 pc. / 60 pc.	14x1/2"
5PK-1604	10 pc. / 60 pc.	16x1/2"
5PK-1804	10 pc. / 60 pc.	18x1/2"
5PK-2004	10 pc. / 60 pc.	20x1/2"
5PK-2005	10 pc. / 50 pc.	20x3/4"
5PK-2605	10 pc. / 40 pc.	26x3/4"
5PK-3206	5 pc. / 20 pc.	32x1"
5PK-4007	3 pc. / 15 pc.	40x1 1/4"
5PK-5007	1 pc. / 10 pc.	50x1 1/4"
5PK-5008	1 pc. / 8 pc.	50x1 1/2"
5PK-6310	1 pc. / 4 pc.	63x2"
5PK-7510	See page 47	75x2"
5PK-7512	See page 47	75x2 1/2"

Type: 5PK-N (CW602)



PK-TOOL p 164

Bend 90° male adapter
Knie 90° buitendraad
Coude 90° mâle
Winkel 90° AG

Article number	Bag / Box	Type
5PK-4007-N	3 pc. / 15 pc.	40x1 1/4"
5PK-5007-N	1 pc. / 10 pc.	50x1 1/4"
5PK-5008-N	1 pc. / 8 pc.	50x1 1/2"
5PK-6310-N	1 pc. / 4 pc.	63x2"

Type: 6PK (CW617)



PK-TOOL p 164

Bend 90° female adapter
Knie 90° binnendraad
Coude 90° femelle
Winkel 90° IG

Article number	Bag / Box	Type
6PK-1404BP*	10 pc. / 60 pc.	14x1/2"
6PK-1603	10 pc. / 60 pc.	16x3/8"
6PK-1604BP*	10 pc. / 60 pc.	16x1/2"
6PK-1804BP*	10 pc. / 60 pc.	18x1/2"
6PK-2004BP*	10 pc. / 60 pc.	20x1/2"
6PK-2005	10 pc. / 50 pc.	20x3/4"
6PK-2605	10 pc. / 50 pc.	26x3/4"
6PK-3206	5 pc. / 20 pc.	32x1"
6PK-4007	5 pc. / 15 pc.	40x1 1/4"
6PK-5007	1 pc. / 8 pc.	50x1 1/4"
6PK-5008	1 pc. / 8 pc.	50x1 1/2"
6PK-6310	1 pc. / 4 pc.	63x2"
6PK-7506	See page 47	75x1"
6PK-7510	See page 47	75x2"
6PK-7512	See page 47	75x2 1/2"
6PK-9014	See page 47	90x3"

* With black plug BP04 1/2"

Type: 6PK-N (CW602)



PK-TOOL p 164

Bend 90° female adapter

Knie 90° binnendraad

Coude 90° femelle

Winkel 90° IG

Article number	Bag / Box	Type
6PK-4007-N	5 pc. / 15 pc.	40x1 1/4"
6PK-5007-N	1 pc. / 8 pc.	50x1 1/4"
6PK-5008-N	1 pc. / 8 pc.	50x1 1/2"
6PK-6310-N	1 pc. / 4 pc.	63x2"

Type: 9PK



T-piece

T-stuk

Pièce en T

T-Stück

Article number	Bag / Box	Type
9PK-141414	10 pc. / 100 pc.	14x14x14
9PK-161616	10 pc. / 60 pc.	16x16x16
9PK-181818	10 pc. / 60 pc.	18x18x18
9PK-202020	10 pc. / 50 pc.	20x20x20
9PK-262626	5 pc. / 30 pc.	26x26x26
9PK-323232	5 pc. / 15 pc.	32x32x32
9PK-404040	5 pc. / 10 pc.	40x40x40
9PK-505050	1 pc. / 6 pc.	50x50x50
9PK-636363	1 pc. / 3 pc.	63x63x63
9PK-757575	See page 47	75x75x75
9PK-909090	See page 47	90x90x90



Type: 10PK



T-reduced centre
T-verlopend
Pièce en T-réduit
T-reduziert

Article number	Bag / Box	Type
10PK-161416	10 pc. / 50 pc.	16x14x16
10PK-181418	10 pc. / 50 pc.	18x14x18
10PK-181618	10 pc. / 50 pc.	18x16x18
10PK-201420	10 pc. / 50 pc.	20x14x20
10PK-201620	10 pc. / 50 pc.	20x16x20
10PK-201820	10 pc. / 50 pc.	20x18x20
10PK-261626	5 pc. / 30 pc.	26x16x26
10PK-261826	5 pc. / 30 pc.	26x18x26
10PK-262026	5 pc. / 30 pc.	26x20x26
10PK-321632	5 pc. / 25 pc.	32x16x32
10PK-321832	5 pc. / 25 pc.	32x18x32
10PK-322032	5 pc. / 25 pc.	32x20x32
10PK-322632	5 pc. / 20 pc.	32x26x32
10PK-401640	5 pc. / 15 pc.	40x16x40
10PK-402040	5 pc. / 15 pc.	40x20x40
10PK-402640	5 pc. / 15 pc.	40x26x40
10PK-403240	5 pc. / 10 pc.	40x32x40
10PK-502050	1 pc. / 6 pc.	50x20x50
10PK-502650	1 pc. / 8 pc.	50x26x50
10PK-503250	1 pc. / 8 pc.	50x32x50
10PK-504050	1 pc. / 6 pc.	50x40x50
10PK-632663	1 pc. / 4 pc.	63x26x63
10PK-633263	1 pc. / 3 pc.	63x32x63
10PK-634063	1 pc. / 3 pc.	63x40x63
10PK-635063	1 pc. / 3 pc.	63x50x63
10PK-754075	See page 47	75x40x75
10PK-755075	See page 47	75x50x75
10PK-756375	See page 47	75x63x75
10PK-904090	See page 47	90x40x90
10PK-905090	See page 47	90x50x90
10PK-906390	See page 47	90x63x90
10PK-907590	See page 47	90x75x90

Type: 10PK-JG



T-reduced centre 16x10JGx16 (ceiling cooling)
T-verlopend 16x10JGx16 (koelplafond)
Pièce en T-réduit 16x10JGx16 (plafond climatisé)
T-reduziert 16x10JGx16 (Klimaatplafond)

Article number	Bag / Box	Type
10PK-16JG1016	10 pc. / 50 pc.	16x10JGx16
10PK-20JG1020	10 pc. / 50 pc.	20x10JGx20

Type: 11PK



T-branch and line reduced

T-2X verlopemd

Pièce en T 2X réduit

T-2X reduziert

Article number	Bag / Box	Type
11PK-161414	10 pc. / 50 pc.	16x14x14
11PK-181616	10 pc. / 50 pc.	18x16x16
11PK-201616	10 pc. / 50 pc.	20x16x16
11PK-201818	10 pc. / 50 pc.	20x18x18
11PK-202016	10 pc. / 50 pc.	20x20x16
11PK-261616	10 pc. / 50 pc.	26x16x16
11PK-261620	5 pc. / 30 pc.	26x16x20
11PK-262016	5 pc. / 30 pc.	26x20x16
11PK-262020	5 pc. / 30 pc.	26x20x20
11PK-262616	5 pc. / 30 pc.	26x26x16
11PK-262620	5 pc. / 30 pc.	26x26x20
11PK-322026	5 pc. / 20 pc.	32x20x26
11PK-322626	5 pc. / 20 pc.	32x26x26
11PK-402032	5 pc. / 15 pc.	40x20x32
11PK-402632	5 pc. / 15 pc.	40x26x32
11PK-403232	5 pc. / 10 pc.	40x32x32
11PK-404026	5 pc. / 10 pc.	40x40x26
11PK-404032	5 pc. / 10 pc.	40x40x32
11PK-502040	1 pc. / 10 pc.	50x20x40
11PK-502640	1 pc. / 10 pc.	50x26x40
11PK-503240	1 pc. / 10 pc.	50x32x40
11PK-504040	1 pc. / 8 pc.	50x40x40
11PK-754040	See page 47	75x40x40
11PK-754050	See page 47	75x40x50
11PK-754063	See page 47	75x40x63
11PK-755050	See page 47	75x50x50
11PK-755063	See page 47	75x50x63
11PK-756363	See page 47	75x63x63
11PK-904040	See page 47	90x40x40
11PK-904050	See page 47	90x40x50
11PK-904063	See page 47	90x40x63
11PK-904075	See page 47	90x40x75
11PK-905050	See page 47	90x50x50
11PK-905063	See page 47	90x50x63
11PK-905075	See page 47	90x50x75
11PK-906363	See page 47	90x63x63
11PK-906375	See page 47	90x63x75
11PK-907575	See page 47	90x75x75



Type: 12PK



T-enlarged branch
T-vergroot
Pièce en T agrandi
T-erweitert

Article number	Bag / Box	Type
12PK-161816	10 pc. / 50 pc.	16x18x16
12PK-162016	10 pc. / 50 pc.	16x20x16
12PK-202620	5 pc. / 30 pc.	20x26x20
12PK-263226	5 pc. / 20 pc.	26x32x26
12PK-324032	5 pc. / 15 pc.	32x40x32
12PK-405040	1 pc. / 8 pc.	40x50x40
12PK-407540	See page 47	40x75x40
12PK-507550	See page 47	50x75x50
12PK-637563	See page 47	63x75x63
12PK-409040	See page 47	40x90x40
12PK-509050	See page 47	50x90x50
12PK-639063	See page 47	63x90x63
12PK-759075	See page 47	75x90x75

Type: 13PK (CW617)



PK-TOOL p 164

T-female centre
T-binnendraad
Pièce en T femelle
T-IG

Article number	Bag / Box	Type
13PK-160416BP*	10 pc. / 50 pc.	16x1/2"x16
13PK-180418BP*	10 pc. / 50 pc.	18x1/2"x18
13PK-200420BP*	10 pc. / 50 pc.	20x1/2"x20
13PK-200520	10 pc. / 30 pc.	20x3/4"x20
13PK-260420BP*	5 pc. / 30 pc.	26x1/2"x20
13PK-260426BP*	5 pc. / 30 pc.	26x1/2"x26
13PK-260526	5 pc. / 30 pc.	26x3/4"x26
13PK-320532	5 pc. / 15 pc.	32x3/4"x32
13PK-320632	5 pc. / 10 pc.	32x1"x32
13PK-320732	5 pc. / 10 pc.	32x1 1/4"x32
13PK-400640	5 pc. / 10 pc.	40x1"x40
13PK-400740	5 pc. / 10 pc.	40x1 1/4"x40
13PK-500850	1 pc. / 4 pc.	50x1 1/2"x50
13PK-631063	1 pc. / 2 pc.	63x2"x63
13PK-750675	See page 48	75x1"x75
13PK-751075	See page 48	75x2"x75
13PK-751275	See page 48	75x2 1/2"x75
13PK-901490	See page 48	90x3"x90

* With black plug BP04 1/2"

Type: 13PK-N (CW602)



PK-TOOL p 164

T-female centre
T-binnendraad
Pièce en T femelle
T-IG

Article number	Bag / Box	Type
13PK-400640-N	5 pc. / 10 pc.	40x1"x40
13PK-400740-N	5 pc. / 10 pc.	40x1 1/4"x40
13PK-500850-N	1 pc. / 4 pc.	50x1 1/2"x50
13PK-631063-N	1 pc. / 2 pc.	63x2"x63

Type: 14PK (CW617)



PK-TOOL p 164

T-male centre
T-buitendraad
Pièce en T mâle
T-AG

Article number	Bag / Box	Type
14PK-160416	10 pc. / 50 pc.	16x1/2"x16
14PK-180418	10 pc. / 50 pc.	18x1/2"x18
14PK-200420	10 pc. / 40 pc.	20x1/2"x20
14PK-200520	10 pc. / 30 pc.	20x3/4"x20
14PK-260426	5 pc. / 30 pc.	26x1/2"x26
14PK-260526	5 pc. / 25 pc.	26x3/4"x26
14PK-260626	5 pc. / 20 pc.	26x1"x26
14PK-320532	5 pc. / 15 pc.	32x3/4"x32
14PK-400640	5 pc. / 10 pc.	40x1"x40
14PK-400740	5 pc. / 10 pc.	40x1 1/4"x40
14PK-500850	1 pc. / 5 pc.	50x1 1/2"x50
14PK-631063	1 pc. / 2 pc.	63x2"x63
14PK-751075	See page 48	75x2"x75
14PK-751275	See page 48	75x2 1/2"x75

Type: 14PK-N (CW602)



PK-TOOL p 164

T-male centre
T-buitendraad
Pièce en T mâle
T-AG

Article number	Bag / Box	Type
14PK-400640-N	5 pc. / 10 pc.	40x1"x40
14PK-400740-N	5 pc. / 10 pc.	40x1 1/4"x40
14PK-500850-N	1 pc. / 5 pc.	50x1 1/2"x50
14PK-631063-N	1 pc. / 2 pc.	63x2"x63



Type: 15PK



Straight coupling
Doorverbinder recht / perssok
Manchon
Kupplung

Article number	Bag / Box	Type
15PK-1414	10 pc. / 150 pc.	14x14
15PK-1616	10 pc. / 150 pc.	16x16
15PK-1818	10 pc. / 100 pc.	18x18
15PK-2020	10 pc. / 80 pc.	20x20
15PK-2626	5 pc. / 50 pc.	26x26
15PK-3232	5 pc. / 30 pc.	32x32
15PK-4040	5 pc. / 25 pc.	40x40
15PK-5050	1 pc. / 12 pc.	50x50
15PK-6363	1 pc. / 9 pc.	63x63
15PK-7575	See page 48	75x75
15PK-9090	See page 48	90x90

Type: 16PK



Reducing coupling
Verloopstuk
Réduction
Kupplung-reduziert

Article number	Bag / Box	Type
16PK-1614	10 pc. / 100 pc.	16x14
16PK-1814	10 pc. / 100 pc.	18x14
16PK-1816	10 pc. / 100 pc.	18x16
16PK-2014	10 pc. / 100 pc.	20x14
16PK-2016	10 pc. / 100 pc.	20x16
16PK-2018	10 pc. / 100 pc.	20x18
16PK-2616	5 pc. / 60 pc.	26x16
16PK-2618	5 pc. / 50 pc.	26x18
16PK-2620	5 pc. / 50 pc.	26x20
16PK-3216	5 pc. / 50 pc.	32x16
16PK-3220	5 pc. / 40 pc.	32x20
16PK-3226	5 pc. / 40 pc.	32x26
16PK-4026	5 pc. / 30 pc.	40x26
16PK-4032	5 pc. / 25 pc.	40x32
16PK-5032	1 pc. / 15 pc.	50x32
16PK-5040	1 pc. / 15 pc.	50x40
16PK-6340	1 pc. / 8 pc.	63x40
16PK-6350	1 pc. / 8 pc.	63x50
16PK-7540	See page 48	75x40
16PK-7550	See page 48	75x50
16PK-7563	See page 48	75x63
16PK-9040	See page 48	90x40
16PK-9050	See page 48	90x50
16PK-9063	See page 48	90x63
16PK-9075	See page 48	90x75

- 1
- 2
- 3
- 4
- 5
- 6
- 7
- 8
- 9
- 10
- 11

Type: 17PK (CW617)



PK-TOOL p 164

Straight male adapter
Recht aansluitstuk buitendraad / Puntstuk
Raccord droit mâle
Übergangsfitting AG

Article number	Bag / Box	Type
17PK-1404	10 pc. / 80 pc.	14x1/2"
17PK-1604	10 pc. / 80 pc.	16x1/2"
17PK-1804	10 pc. / 80 pc.	18x1/2"
17PK-1805	10 pc. / 50 pc.	18x3/4"
17PK-2004	10 pc. / 80 pc.	20x1/2"
17PK-2005	10 pc. / 50 pc.	20x3/4"
17PK-2605	10 pc. / 50 pc.	26x3/4"
17PK-2606	10 pc. / 40 pc.	26x1"
17PK-3206	10 pc. / 40 pc.	32x1"
17PK-3207	5 pc. / 25 pc.	32x1 1/4"
17PK-4006	5 pc. / 25 pc.	40x1"
17PK-4007	5 pc. / 25 pc.	40x1 1/4"
17PK-5008	1 pc. / 10 pc.	50x1 1/2"
17PK-6310	1 pc. / 6 pc.	63x2"
17PK-7510	See page 49	75x2"
17PK-7512	See page 49	75x2 1/2"

Type: 17PK-N (CW602)



PK-TOOL p 164

Straight male adapter
Recht aansluitstuk buitendraad / Puntstuk
Raccord droit mâle
Übergangsfitting AG

Article number	Bag / Box	Type
17PK-4006-N	5 pc. / 25 pc.	40x1"
17PK-4007-N	5 pc. / 25 pc.	40x1 1/4"
17PK-5008-N	1 pc. / 10 pc.	50x1 1/2"
17PK-6310-N	1 pc. / 6 pc.	63x2"



Type: 18PK (CW617)



PK-TOOL p 164

Straight female adapter
Recht aansluitstuk binnendraad / Schroefbus
Raccord droit femelle
Übergangsfitting IG

Article number	Bag / Box	Type
18PK-1404	10 pc. / 80 pc.	14x1/2"
18PK-1604	10 pc. / 80 pc.	16x1/2"
18PK-1804	10 pc. / 80 pc.	18x1/2"
18PK-1805	10 pc. / 50 pc.	18x3/4"
18PK-2004	10 pc. / 80 pc.	20x1/2"
18PK-2005	10 pc. / 50 pc.	20x3/4"
18PK-2605	10 pc. / 50 pc.	26x3/4"
18PK-2606	10 pc. / 40 pc.	26x1"
18PK-3206	10 pc. / 40 pc.	32x1"
18PK-3207	5 pc. / 25 pc.	32x1 1/4"
18PK-4006	5 pc. / 25 pc.	40x1"
18PK-4007	5 pc. / 25 pc.	40x1 1/4"
18PK-5008	1 pc. / 10 pc.	50x1 1/2"
18PK-6310	1 pc. / 6 pc.	63x2"
18PK-7506	See page 49	75x1"
18PK-7510	See page 49	75x2"
18PK-7512	See page 49	75x2 1/2"
18PK-9014	See page 49	90x3"

Type: 18PK-N (CW602)



PK-TOOL p 164

Straight female adapter
Recht aansluitstuk binnendraad / Schroefbus
Raccord droit femelle
Übergangsfitting IG

Article number	Bag / Box	Type
18PK-4006-N	5 pc. / 25 pc.	40x1"
18PK-4007-N	5 pc. / 25 pc.	40x1 1/4"
18PK-5008-N	1 pc. / 10 pc.	50x1 1/2"
18PK-6310-N	1 pc. / 6 pc.	63x2"

Type: 19PK



Press fit with swivel to eurocone
Perskoppeling met wartel en euroconus aansluiting
Raccord à sertir avec ecrou à visser eurocone
Pressfitting mit Drehbar und Eurokonus

Article number	Bag / Box	Type
19PK-1605	10 pc. / 80 pc.	16x3/4"
19PK-2005	10 pc. / 80 pc.	20x3/4"

Type: 26PK



Press fitting with swivel and flat sealing
 Perskoppeling met wartel en vlakke dichting
 Raccord avec écrou et joint plat
 Pressfitting mit Drehbar und flach Versiegelung

Article number	Bag / Box	Type
26PK-1605	10 pc. / 80 pc.	16x3/4"
26PK-2005	10 pc. / 80 pc.	20x3/4"

Type: 26PK (CW617)



Press fitting with swivel and flat sealing
 Perskoppeling met wartel en vlakke dichting
 Raccord avec écrou et joint plat
 Pressfitting mit Drehbar und flach Versiegelung

Article number	Bag / Box	Type
26PK-4008	5 pc. / 15 pc.	40x1 1/2"
26PK-5010	1 pc. / 10 pc.	50x2"
26PK-6312	1 pc. / 6 pc.	63x2 1/2"

Type: 27PK



45° bend
 Bocht 45°
 Coude 45°
 Winkel 45°

Article number	Bag / Box	Type
27PK-4040	5 pc. / 25 pc.	40x40
27PK-5050	1 pc. / 10 pc.	50x50
27PK-6363	1 pc. / 5 pc.	63x63
27PK-7575	See page 49	75x75
27PK-9090	See page 49	90x90

Type: 28PK-04



Bracket wallplate for 2PK, 6PK and 13PK, interaxis 153mm
 Muurplaatbeugel voor 2PK, 6PK en 13PK, asafstand 153mm
 Attache culasse pour 2PK, 6PK et 13PK, entraxe 153mm
 Bügel Wandscheibe für 28PK-2PK1604 und 28PK-6PK-1604, Mitte-zu-Mitte-Abstand

Article number	Box	Type
28PK-04	50 pc.	1/2"



Type: 28PK-2PK1604



Double backplate 153mm centres for art. 2PK-1604
 Dubbele muurplaat 153mm asafstand voor art. 2PK-1604
 Culasse double, entraxe 153mm pour art. 2PK-1604
 Wandwinkel doppelt 153mm Abstand für Art. 2PK-1604

Article number	Bag / Box	Type
28PK-2PK1604BP *	2 pc. / 10 pc.	2x(16x1/2")

* With black plug BP04 1/2"
 TILL EXHAUSTION OF STOCK

Type: 28PK-6PK1604



Double backplate 153mm centres for art. 6PK-1604
 Dubbele muurplaat 153mm asafstand voor art. 6PK-1604
 Culasse double, entraxe 153mm pour art. 6PK-1604
 Wandwinkel doppelt 153mm Abstand für Art. 6PK-1604

Article number	Bag / Box	Type
28PK-6PK1604BP *	2 pc. / 18 pc.	2x(16x1/2")

* With black plug BP04 1/2"
 TILL EXHAUSTION OF STOCK

Type: 53PK



Easy mounting fitting
 Eenvoudige montage fitting
 Raccord montage facile
 Einfache Montage Fitting

Article number	Bag / Box	Type
53PK40	1 pc. / 20 pc.	40x40
53PK50	1 pc. / 9 pc.	50x50
53PK63	1 pc. / 6 pc.	63x63

for Ø16, 20, 26 and 32: chapter 4, article 52P

- 1
- 2
- 3
- 4
- 5
- 6
- 7
- 8
- 9
- 10
- 11

Type: 1PKW



Elbow 90°
Knie 90°
Coude 90°
Winkel 90°

Article number	Bag / Box	Type
1PKW-1616	10 pc. / 120 pc.	16x16
1PKW-2020	10 pc. / 80 pc.	20x20
1PKW-2626	5 pc. / 50 pc.	26x26
1PKW-3232	5 pc. / 30 pc.	32x32

Type: 2PKW (CW617)



Backplate elbow female
Sanitair muurplaat binnendraad
Culasse pour sanitaire
Sanitär Wandscheibe IG

Article number	Bag / Box	Type
2PKW-1604	10 pc. / 50 pc.	16x1/2" (56 mm)
2PKW-2004	10 pc. / 50 pc.	20x1/2" (56 mm)
2PKW-2005	5 pc. / 30 pc.	20x3/4" (56 mm)
2PKW-2605	5 pc. / 30 pc.	26x3/4" (56 mm)

Type: 2PKW-N (CW602)



Backplate elbow female
Sanitair muurplaat binnendraad
Culasse pour sanitaire
Sanitär Wandscheibe IG

Article number	Bag / Box	Type
2PKW-1604-N	10 pc. / 50 pc.	16x1/2" (56 mm)
2PKW-2004-N	10 pc. / 50 pc.	20x1/2" (56 mm)
2PKW-2005-N	5 pc. / 30 pc.	20x3/4" (56 mm)
2PKW-2605-N	5 pc. / 30 pc.	26x3/4" (56 mm)

Type: 2PKW-K (CW617)



Backplate elbow female, short model,
Sanitair muurplaat binnendraad, kort model
Culasse pour sanitaire, modèle court
Sanitär Wandscheibe IG, kurzes Modell

Article number	Bag / Box	Type
2PKW-1604K	10 pc. / 50 pc.	16x1/2" (40 mm)

Accessory 2PKW, 2PKW-N, 2PKW-K: galvanised bracket plate - see page 168



PLP-P-PK



PLF-P-PK



Type: 3PKW (CW617)



Double backplate elbow female, short model
 Sanitair muurplaat binnendraad dubbel, laag
 Culasse double pour sanitaire, modèle court
 Sanitär Wandscheibe doppelt IG, kurzes Modell

Article number	Bag / Box	Type
3PKW-160416	10 pc. / 30 pc.	16x1/2"x16 (40 mm)
3PKW-200420	10 pc. / 30 pc.	20x1/2"x20 (40 mm)

Type: 3PKW-N (CW602)



Double backplate elbow female, short model
 Sanitair muurplaat binnendraad dubbel, laag
 Culasse double pour sanitaire, modèle court
 Sanitär Wandscheibe doppelt IG, kurzes Modell

Article number	Bag / Box	Type
3PKW-160416-N	10 pc. / 30 pc.	16x1/2"x16 (40 mm)
3PKW-200420-N	10 pc. / 30 pc.	20x1/2"x20 (40 mm)

Type: 5PKW (CW617)



PK-TOOL p 164

Bend 90° male adapter
 Knie 90° buitendraad
 Coude 90° mâle
 Winkel 90° AG

Article number	Bag / Box	Type
5PKW-1604	10 pc. / 60 pc.	16x1/2"
5PKW-2004	10 pc. / 60 pc.	20x1/2"
5PKW-2005	10 pc. / 50 pc.	20x3/4"
5PKW-2605	10 pc. / 40 pc.	26x3/4"
5PKW-3206	5 pc. / 20 pc.	32x1"

Type: 5PKW-N (CW602)



PK-TOOL p 164

Bend 90° male adapter
 Knie 90° buitendraad
 Coude 90° mâle
 Winkel 90° AG

Article number	Bag / Box	Type
5PKW-1604-N	10 pc. / 60 pc.	16x1/2"
5PKW-2004-N	10 pc. / 60 pc.	20x1/2"
5PKW-2005-N	10 pc. / 50 pc.	20x3/4"
5PKW-2605-N	10 pc. / 40 pc.	26x3/4"
5PKW-3206-N	5 pc. / 20 pc.	32x1"

Type: 6PKW (CW617)



PK-TOOL p 164

Bend 90° female adapter

Knie 90° binnendraad

Coude 90° femelle

Winkel 90° IG

Article number	Bag / Box	Type
6PKW-1603	10 pc. / 60 pc.	16x3/8"
6PKW-1604	10 pc. / 60 pc.	16x1/2"
6PKW-2004	10 pc. / 60 pc.	20x1/2"
6PKW-2005	10 pc. / 50 pc.	20x3/4"
6PKW-2605	10 pc. / 50 pc.	26x3/4"
6PKW-3206	5 pc. / 20 pc.	32x1"

Type: 6PKW-N (CW602)



PK-TOOL p 164

Bend 90° female adapter

Knie 90° binnendraad

Coude 90° femelle

Winkel 90° IG

Article number	Bag / Box	Type
6PKW-1603-N	10 pc. / 60 pc.	16x3/8"
6PKW-1604-N	10 pc. / 60 pc.	16x1/2"
6PKW-2004-N	10 pc. / 60 pc.	20x1/2"
6PKW-2005-N	10 pc. / 50 pc.	20x3/4"
6PKW-2605-N	10 pc. / 50 pc.	26x3/4"
6PKW-3206-N	5 pc. / 20 pc.	32x1"

Type: 9PKW



T-piece

T-stuk

Pièce en T

T-Stück

Article number	Bag / Box	Type
9PKW-161616	10 pc. / 60 pc.	16x16x16
9PKW-202020	10 pc. / 50 pc.	20x20x20
9PKW-262626	5 pc. / 30 pc.	26x26x26
9PKW-323232	5 pc. / 15 pc.	32x32x32

Type: 10PKW



T-reduced centre

T-verlopend

T-réduit

T-reduziert

Article number	Bag / Box	Type
10PKW-201620	10 pc. / 50 pc.	20x16x20
10PKW-261626	5 pc. / 30 pc.	26x16x26
10PKW-262026	5 pc. / 30 pc.	26x20x26
10PKW-321632	5 pc. / 25 pc.	32x16x32
10PKW-322032	5 pc. / 25 pc.	32x20x32
10PKW-322632	5 pc. / 20 pc.	32x26x32



Type: 11PKW



T-branch and line reduced

T-2X verlopend

T-2X réduit

T-2X reduziert

Article number	Bag / Box	Type
11PKW-201616	10 pc. / 50 pc.	20x16x16
11PKW-202016	10 pc. / 50 pc.	20x20x16
11PKW-261616	10 pc. / 50 pc.	26x16x16
11PKW-261620	5 pc. / 30 pc.	26x16x20
11PKW-262016	5 pc. / 30 pc.	26x20x16
11PKW-262020	5 pc. / 30 pc.	26x20x20
11PKW-262616	5 pc. / 30 pc.	26x26x16
11PKW-262620	5 pc. / 30 pc.	26x26x20
11PKW-322026	5 pc. / 20 pc.	32x20x26
11PKW-322626	5 pc. / 20 pc.	32x26x26

Type: 12PKW



T-enlarged branch

T-vergroot

T-agrandi

T-erweitert

Article number	Bag / Box	Type
12PKW-162016	10 pc. / 50 pc.	16x20x16
12PKW-202620	5 pc. / 30 pc.	20x26x20
12PKW-263226	5 pc. / 20 pc.	26x32x26

Type: 13PKW (CW617)



T-female centre

T-binnendraad

T-femelle

T-IG

Article number	Bag / Box	Type
13PKW-160416	10 pc. / 50 pc.	16x1/2"x16
13PKW-200420	10 pc. / 50 pc.	20x1/2"x20
13PKW-200520	10 pc. / 30 pc.	20x3/4"x20
13PKW-260426	5 pc. / 30 pc.	26x1/2"x26
13PKW-260526	5 pc. / 30 pc.	26x3/4"x26
13PKW-320532	5 pc. / 15 pc.	32x3/4"x32
13PKW-320632	5 pc. / 10 pc.	32x1"x32



PK-TOOL p 164

Type: 13PKW-N (CW602)



PK-TOOL p 164

T-female centre

T-binnendraad

T-femelle

T-IG

Article number	Bag / Box	Type
13PKW-160416-N	10 pc. / 50 pc.	16x1/2"x16
13PKW-200420-N	10 pc. / 50 pc.	20x1/2"x20
13PKW-200520-N	10 pc. / 30 pc.	20x3/4"x20
13PKW-260426-N	5 pc. / 30 pc.	26x1/2"x26
13PKW-260526-N	5 pc. / 30 pc.	26x3/4"x26
13PKW-320532-N	5 pc. / 15 pc.	32x3/4"x32
13PKW-320632-N	5 pc. / 10 pc.	32x1"x32

Type: 14PKW (CW617)



PK-TOOL p 164

T-male centre

T-buitendraad

T-mâle

T-AG

Article number	Bag / Box	Type
14PKW-160416	10 pc. / 50 pc.	16x1/2"x16
14PKW-200420	10 pc. / 40 pc.	20x1/2"x20
14PKW-200520	10 pc. / 30 pc.	20x3/4"x20
14PKW-320532	5 pc. / 15 pc.	32x3/4"x32

Type: 14PKW-N (CW602)



PK-TOOL p 164

T-male centre

T-buitendraad

T-mâle

T-AG

Article number	Bag / Box	Type
14PKW-160416-N	10 pc. / 50 pc.	16x1/2"x16
14PKW-200420-N	10 pc. / 40 pc.	20x1/2"x20
14PKW-200520-N	10 pc. / 30 pc.	20x3/4"x20

Type: 15PKW



Straight coupling

Doorverbinder recht

Manchon

Kupplung

Article number	Bag / Box	Type
15PKW-1616	10 pc. / 150 pc.	16x16
15PKW-2020	10 pc. / 80 pc.	20x20
15PKW-2626	5 pc. / 50 pc.	26x26
15PKW-3232	5 pc. / 30 pc.	32x32



Type: 16PKW



Reducing coupling
Verloopstuk
Réduction
Kupplung-reduziert

Article number	Bag / Box	Type
16PKW-2016	10 pc. / 100 pc.	20x16
16PKW-2616	5 pc. / 60 pc.	26x16
16PKW-2620	5 pc. / 50 pc.	26x20
16PKW-3216	5 pc. / 50 pc.	32x16
16PKW-3220	5 pc. / 40 pc.	32x20
16PKW-3226	5 pc. / 40 pc.	32x26

Type: 17PKW (CW617)



PK-TOOL p 164

Straight male adapter
Recht aansluitstuk buitendraad / Puntstuk
Raccord droit mâle
Übergangsfitting AG

Article number	Bag / Box	Type
17PKW-1604	10 pc. / 80 pc.	16x1/2"
17PKW-2004	10 pc. / 80 pc.	20x1/2"
17PKW-2005	10 pc. / 50 pc.	20x3/4"
17PKW-2605	10 pc. / 50 pc.	26x3/4"
17PKW-2606	10 pc. / 40 pc.	26x1"
17PKW-3206	10 pc. / 40 pc.	32x1"
17PKW-3207	5 pc. / 25 pc.	32 x 1 1/4"

Type: 17PKW-N (CW602)



PK-TOOL p 164

Straight male adapter
Recht aansluitstuk buitendraad / Puntstuk
Raccord droit mâle
Übergangsfitting AG

Article number	Bag / Box	Type
17PKW-1604-N	10 pc. / 80 pc.	16x1/2"
17PKW-2004-N	10 pc. / 80 pc.	20x1/2"
17PKW-2005-N	10 pc. / 50 pc.	20x3/4"
17PKW-2605-N	10 pc. / 50 pc.	26x3/4"
17PKW-2606-N	10 pc. / 40 pc.	26x1"
17PKW-3206-N	10 pc. / 40 pc.	32x1"
17PKW-3207-N	5 pc. / 25 pc.	32 x 1 1/4"

- 1
- 2
- 3
- 4
- 5
- 6
- 7
- 8
- 9
- 10
- 11

Type: 18PKW (CW617)



PK-TOOL p 164

Straight female adapter
 Recht aansluitstuk binnendraad / Schroefbus
 Raccord droit femelle
 Übergangsfitting IG

Article number	Bag / Box	Type
18PKW-1604	10 pc. / 80 pc.	16x1/2"
18PKW-2004	10 pc. / 80 pc.	20x1/2"
18PKW-2005	10 pc. / 50 pc.	20x3/4"
18PKW-2605	10 pc. / 50 pc.	26x3/4"
18PKW-2606	10 pc. / 40 pc.	26x1"
18PKW-3206	10 pc. / 40 pc.	32x1"
18PKW-3207	5 pc. / 25 pc.	32x1 1/4"

Type: 18PKW-N (CW602)



PK-TOOL p 164

Straight female adapter
 Recht aansluitstuk binnendraad / Schroefbus
 Raccord droit femelle
 Übergangsfitting IG

Article number	Bag / Box	Type
18PKW-1604-N	10 pc. / 80 pc.	16x1/2"
18PKW-2004-N	10 pc. / 80 pc.	20x1/2"
18PKW-2005-N	10 pc. / 50 pc.	20x3/4"
18PKW-2605-N	10 pc. / 50 pc.	26x3/4"
18PKW-2606-N	10 pc. / 40 pc.	26x1"
18PKW-3206-N	10 pc. / 40 pc.	32x1"
18PKW-3207-N	5 pc. / 25 pc.	32x1 1/4"

Type: 19PKW



Press fitting to eurocone
 Perskoppeling met euroconus aansluiting
 Raccord avec raccord à visser eurocone
 Pressfitting mit Eurokonus

Article number	Bag / Box	Type
19PKW-1605	10 pc. / 80 pc.	16x3/4"
19PKW-2005	10 pc. / 80 pc.	20x3/4"

Type: 26PKW



Press fitting with flat sealing
 Perskoppeling met vlakke dichting
 Raccord avec etachéité plate
 Pressfitting mit flach Versiegelung

Article number	Bag / Box	Type
26PKW-1605	10 pc. / 80 pc.	16x3/4"
26PKW-2005	10 pc. / 80 pc.	20x3/4"



Gas: only allowed in countries where has been a HENCO GAS testing + certificate is available! (See www.henco.be)
 Gas: enkel toegelaten in landen waar er een HENCO GAS keur is + een certificaat voorhanden is! (zie www.henco.be)
 Gaz: seulement permis dans des pays où le contrôle a eu lieu + certificat est disponible! (Consultez www.henco.be)
 Gas: nur zugelassen in Länder wo HENCO GAS Prüfung geschehen ist + Zertifikat vorhanden ist! (Siehe www.henco.be)

Henco press fittings PVDF for gas in combination with standard pipe gas, see page 19



Type: 1PKG



Elbow 90°
 Knie 90°
 Coude 90°
 Winkel 90°

Article number	Bag / Box	Type
1PKG-1616	10 pc. / 120 pc.	16x16
1PKG-2020	10 pc. / 80 pc.	20x20
1PKG-2626	5 pc. / 50 pc.	26x26
1PKG-3232	5 pc. / 30 pc.	32x32
1PKG-4040	5 pc. / 20 pc.	40x40

Type: 2PKG



Backplate elbow female
 Muurplaat binnendraad
 Culasse femelle
 Wandscheibe IG

Article number	Bag / Box	Type
2PKG-1603	10 pc. / 50 pc.	16x3/8" (56 mm)
2PKG-1604BP *	10 pc. / 50 pc.	16x1/2" (56 mm)
2PKG-2004BP *	10 pc. / 50 pc.	20x1/2" (56 mm)
2PKG-2005	5 pc. / 30 pc.	20x3/4" (56 mm)
2PKG-2605	5 pc. / 30 pc.	26x3/4" (56 mm)

* With black plug BP04 1/2"

Type: 2PKG-K



Backplate elbow female, short model
 Muurplaat binnendraad, laag
 Culasse femelle, modèle court
 Wandscheibe IG, kurzes Modell

Article number	Bag / Box	Type
2PKG-1604KBP *	10 pc. / 50 pc.	16x1/2" (40 mm)

* With black plug BP04 1/2"

Type: 3PKG



Double backplate elbow female, short model

Muurplaat binnendraad dubbel, laag

Culasse double, modèle court

Wandscheibe doppelt IG, kurzes Modell

Article number	Bag / Box	Type
3PKG-200420BP *	10 pc. / 30 pc.	20x1/2"x20 (40 mm)

* With black plug BP04 1/2"

Type: 5PKG



PK-TOOL p 164

Bend 90° male adapter

Knie 90° buitendraad

Coude 90° mâle

Winkel 90° AG

Article number	Bag / Box	Type
5PKG-1604	10 pc. / 60 pc.	16x1/2"
5PKG-2004	10 pc. / 60 pc.	20x1/2"
5PKG-2005	10 pc. / 50 pc.	20x3/4"
5PKG-2605	10 pc. / 40 pc.	26x3/4"
5PKG-3206	5 pc. / 20 pc.	32x1"
5PKG-4007	5 pc. / 15 pc.	40x1 1/4"

Type: 6PKG



PK-TOOL p 164

Bend 90° female adapter

Knie 90° binnendraad

Coude 90° femelle

Winkel 90° IG

Article number	Bag / Box	Type
6PKG-1604BP *	10 pc. / 60 pc.	16x1/2"
6PKG-2004BP *	10 pc. / 60 pc.	20x1/2"
6PKG-2005	10 pc. / 50 pc.	20x3/4"
6PKG-2605	10 pc. / 50 pc.	26x3/4"
6PKG-3206	5 pc. / 20 pc.	32x1"
6PKG-4007	5 pc. / 15 pc.	40x1 1/4"

* With black plug BP04 1/2"

Type: 9PKG



T-piece

T-stuk

Pièce en T

T-Stück

Article number	Bag / Box	Type
9PKG-161616	10 pc. / 60 pc.	16x16x16
9PKG-202020	10 pc. / 50 pc.	20x20x20
9PKG-262626	5 pc. / 30 pc.	26x26x26
9PKG-323232	5 pc. / 15 pc.	32x32x32
9PKG-404040	5 pc. / 10 pc.	40x40x40



Type: 10PKG



T-reduced centre
T-verlopend
Pièce en T réduit
T-reduziert

Article number	Bag / Box	Type
10PKG-201620	10 pc. / 50 pc.	20x16x20
10PKG-261626	5 pc. / 30 pc.	26x16x26
10PKG-262026	5 pc. / 30 pc.	26x20x26
10PKG-321632	5 pc. / 25 pc.	32x16x32
10PKG-322032	5 pc. / 25 pc.	32x20x32
10PKG-322632	5 pc. / 20 pc.	32x26x32
10PKG-401640	5 pc. / 15 pc.	40x16x40
10PKG-402040	5 pc. / 15 pc.	40x20x40
10PKG-402640	5 pc. / 15 pc.	40x26x40
10PKG-403240	5 pc. / 10 pc.	40x32x40

Type: 11PKG



T-branch and line reduced
T-2X verlopend
Pièce en T 2X réduit
T-2X reduziert

Article number	Bag / Box	Type
11PKG-201616	10 pc. / 50 pc.	20x16x16
11PKG-202016	10 pc. / 50 pc.	20x20x16
11PKG-261620	5 pc. / 30 pc.	26x16x20
11PKG-262016	5 pc. / 30 pc.	26x20x16
11PKG-262020	5 pc. / 30 pc.	26x20x20
11PKG-262616	5 pc. / 30 pc.	26x26x16
11PKG-262620	5 pc. / 30 pc.	26x26x20
11PKG-322026	5 pc. / 20 pc.	32x20x26
11PKG-322626	5 pc. / 20 pc.	32x26x26
11PKG-402032	5 pc. / 15 pc.	40x20x32
11PKG-402632	5 pc. / 15 pc.	40x26x32
11PKG-403232	5 pc. / 10 pc.	40x32x32
11PKG-404026	5 pc. / 10 pc.	40x40x26
11PKG-404032	5 pc. / 10 pc.	40x40x32

Type: 12PKG



T-enlarged branch
T-vergroot
Pièce en T agrandi
T-erweitert

Article number	Bag / Box	Type
12PKG-162016	10 pc. / 50 pc.	16x20x16
12PKG-202620	5 pc. / 30 pc.	20x26x20
12PKG-263226	5 pc. / 20 pc.	26x32x26
12PKG-324032	5 pc. / 15 pc.	32x40x32

- 1
- 2
- 3
- 4
- 5
- 6
- 7
- 8
- 9
- 10
- 11

Type: 13PKG



PK-TOOL p 164

T-female branch
T-binnendraad
Pièce en T femelle
T-IG

Article number	Bag / Box	Type
13PKG-160416BP *	10 pc. / 50 pc.	16X1/2"x16
13PKG-200420BP *	10 pc. / 50 pc.	20x1/2"x20
13PKG-200520	10 pc. / 30 pc.	20x3/4"x20
13PKG-260420BP *	5 pc. / 30 pc.	26x1/2"x20
13PKG-260426BP *	5 pc. / 30 pc.	26x1/2"x26
13PKG-260526	5 pc. / 30 pc.	26x3/4"x26
13PKG-320532	5 pc. / 15 pc.	32x3/4"x32
13PKG-320632	5 pc. / 10 pc.	32x1"x32
13PKG-320732	5 pc. / 10 pc.	32x1 1/4"x32
13PKG-400640	5 pc. / 10 pc.	40x1"x40
13PKG-400740	5 pc. / 10 pc.	40x1 1/4"x40

* With black plug BP04 1/2"

Type: 14PKG



PK-TOOL p 164

T-male branch
T-buitendraad
Pièce en T mâle
T-AG

Article number	Bag / Box	Type
14PKG-160416	10 pc. / 50 pc.	16x1/2"x16
14PKG-200420	10 pc. / 40 pc.	20x1/2"x20
14PKG-260426	5 pc. / 30 pc.	26x1/2"x26
14PKG-260626	5 pc. / 20 pc.	26x1"x26
14PKG-320532	5 pc. / 15 pc.	32x3/4"x32
14PKG-400740	5 pc. / 10 pc.	40x1 1/4"x40

Type: 15PKG



Straight coupling
Doorverbinder recht / perssok
Manchon
Kupplung

Article number	Bag / Box	Type
15PKG-1616	10 pc. / 150 pc.	16x16
15PKG-2020	10 pc. / 80 pc.	20x20
15PKG-2626	5 pc. / 50 pc.	26x26
15PKG-3232	5 pc. / 30 pc.	32x32
15PKG-4040	5 pc. / 25 pc.	40x40



Type: 16PKG



Reducing coupling
Verloopstuk
Réduction
Kupplung-reduziert

Article number	Bag / Box	Type
16PKG-2016	10 pc. / 100 pc.	20x16
16PKG-2616	5 pc. / 60 pc.	26x16
16PKG-2620	5 pc. / 50 pc.	26x20
16PKG-3216	5 pc. / 50 pc.	32x16
16PKG-3220	5 pc. / 40 pc.	32x20
16PKG-3226	5 pc. / 40 pc.	32x26
16PKG-4026	5 pc. / 30 pc.	40x26
16PKG-4032	5 pc. / 25 pc.	40x32

Type: 17PKG



PK-TOOL p 164

Straight male adapter
Recht aansluitstuk buitendraad / Puntstuk
Raccord droit mâle
Übergangsfitting AG

Article number	Bag / Box	Type
17PKG-1604	10 pc. / 80 pc.	16x1/2"
17PKG-2004	10 pc. / 80 pc.	20x1/2"
17PKG-2005	10 pc. / 50 pc.	20x3/4"
17PKG-2605	10 pc. / 50 pc.	26x3/4"
17PKG-2606	10 pc. / 40 pc.	26x1"
17PKG-3206	10 pc. / 40 pc.	32x1"
17PKG-3207	5 pc. / 25 pc.	32x1 1/4"
17PKG-4006	5 pc. / 25 pc.	40x1"
17PKG-4007	5 pc. / 25 pc.	40x1 1/4"

Type: 18PKG



PK-TOOL p 164

Straight female adapter
Recht aansluitstuk binnendraad / Schroefbus
Raccord droit femelle
Übergangsfitting IG

Article number	Bag / Box	Type
18PKG-1604	10 pc. / 80 pc.	16x1/2"
18PKG-2004	10 pc. / 80 pc.	20x1/2"
18PKG-2005	10 pc. / 50 pc.	20x3/4"
18PKG-2605	10 pc. / 50 pc.	26x3/4"
18PKG-2606	10 pc. / 40 pc.	26x1"
18PKG-3206	10 pc. / 40 pc.	32x1"
18PKG-3207	5 pc. / 25 pc.	32x1 1/4"
18PKG-4006	5 pc. / 25 pc.	40x1"
18PKG-4007	5 pc. / 25 pc.	40x1 1/4"

- 1
- 2
- 3
- 4
- 5
- 6
- 7
- 8
- 9
- 10
- 11



C. PKG

Type: 27PKG



45° bend
Bocht 45°
Coude 45°
Winkel 45°

Article number	Bag / Box	Type
27PKG-4040	5 pc. / 25 pc.	40x40

1

2

3

4

5

6

7

8

9

10

11

D. SUPER SIZES



Detailed overview of Super Size possibilities

A = 75mm

B = 90-110mm

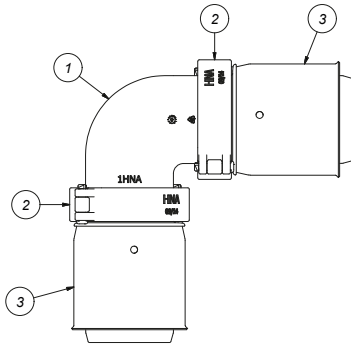

1PK

- 1 HNA or 1HNB
- 2 HNA or HNB
- 3 8HNA-PK40 or 8HNA-PK50 or 8HNA-PK63 or 8HNA-PK75 or 8HNB-PK90

Example / Voorbeeld / Exemple / Beispiel

1PK-7575 = 1x 1HNA + 2xHNA + 2x 8HNA-PK75

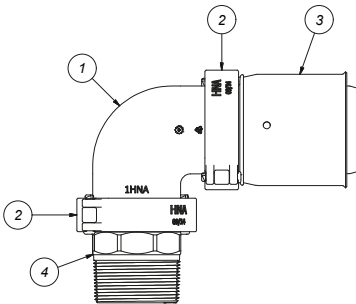

5PK / 6PK

- 1 1HNA or 1HNB
- 2 HNA or HNB
- 3 8HNA-PK75 or 8HNB-PK90
- 4 17HNA-10 or 17HNA-12 or 18HNA-06 or 18HNA-10 or 18HNA-12 or 18HNB-14

Example / Voorbeeld / Exemple / Beispiel

5PK-7510 = 1x 1HNA + 2xHNA + 1x 8HNA-PK75 + 1x17HNA-10

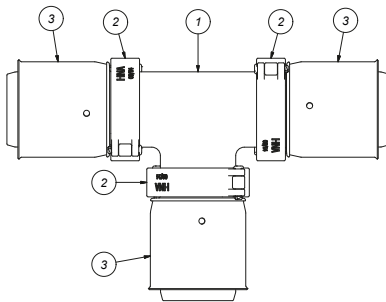

9PK / 10PK / 11PK / 12PK (75mm)

- 1 9HNA
- 2 HNA
- 3 8HNA-PK40 or 8HNA-PK50 or 8HNA-PK63 or 8HNA-PK75

Example / Voorbeeld / Exemple / Beispiel

9PK-757575 = 1x 9HNA + 3xHNA + 3x 8HNA-PK75

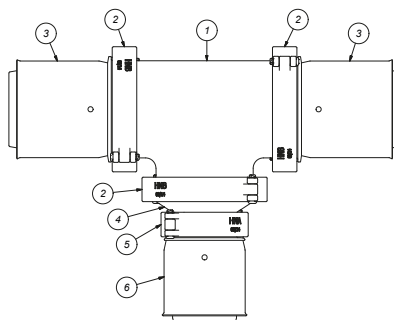

10PK / 11PK / 12PK (90mm)

- 1 9HNB
- 2 HNB
- 3 8HNB-PK90
- 4 16HNBA
- 5 HNA
- 6 8HNA-PK40 or 8HNA-PK50 or 8HNA-PK63 or 8HNA-PK75

Example / Voorbeeld / Exemple / Beispiel

10PK-905090 = 1x 9HNB + 3x HNB + 2x 8HNB-PK90 + 1x 16HNBA + 1xHNA + 8HNA-PK50

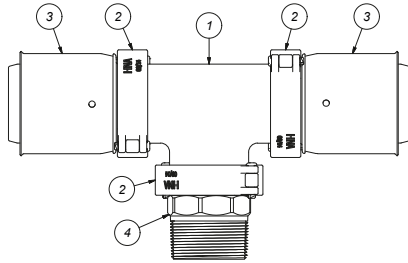

13PK / 14PK

- 1 9HNA or 9HNB
- 2 HNA or HNB
- 3 8HNA-PK75 or 8HNB-PK90
- 4 17HNA-10 or 17HNA-12 or 18HNA-06 or 18HNA-10 or 18HNA-12 or 18HNB-14

Example / Voorbeeld / Exemple / Beispiel

13PK-750675 = 1x 9HNA + 3x HNA + 8HNA-PK75 + 18HNA-06

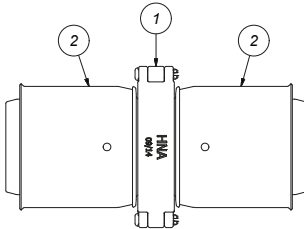

15PK / 16PK

- 1 HNA or HNB
- 2 8HNA-PK75 or 8HNB-PK90

Example / Voorbeeld / Exemple / Beispiel

15PK-7575 = 1x HNA + 2x 8HNA-PK75

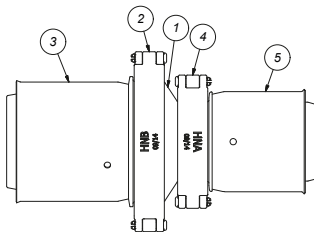

16PK

- 1 16HNBA
- 2 HNB
- 3 8HNB-PK90
- 4 HNA
- 5 8HNA-PK40 or 8HNA-PK50 or 8HNA-PK63 or 8HNA-PK75

Example / Voorbeeld / Exemple / Beispiel

16PK-9063 = 1x 16HNBA + 1x HNB + 1x 8HNB-PK90 + 1x HNA + 1x 8HNA-PK63

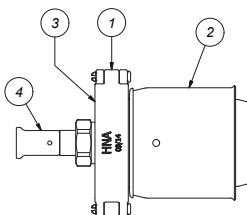

16PK-7516

- 1 HNA
- 2 8HNA-PK75
- 3 HNA-05
- 4 19P-1605 or 19P-1805 or 19P-2005 or 33P-1605 or 19SK-1605 or 19SK-2005

D. SUPER SIZES

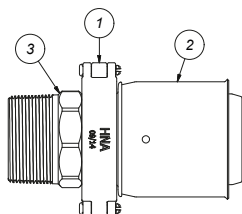

17PK / 18PK

- 1 HNA or HNB
- 2 8HNA-PK40 or 8HNA-PK50 or 8HNA-PK63 8HNA-PK75 or 8HNB-PK90
- 3 17HNA-10 or 17HNA-12 or 18HNB-06 or 18HNB-10 or 18HNB-12 or 18HNB-14

Example / Voorbeeld / Exemple / Beispiel

18PK-7512 = 1x HNA + 1x 8HNA-PK75 + 1x 18HNA-12

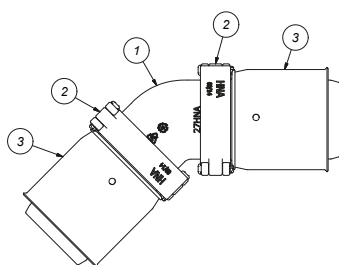

27PK

- 1 27HNA or 27HNB
- 2 HNA or HNB
- 3 8HNA-PK75 or 8HNB-PK90

Example / Voorbeeld / Exemple / Beispiel

27PK-9090 = 1x 27HNB + 2xHNB + 2x 8HNB-PK90

SUPER SIZE ASSEMBLY

*HN connection = click and lock connection
*PK connection = press connection

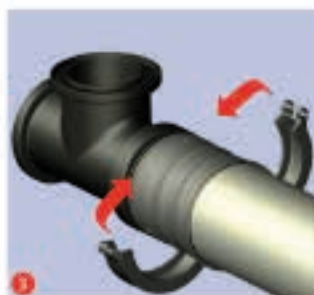

D. SUPER SIZES

Type: 1HN



Elbow 90°
Knie 90°
Coude 90°
Winkel 90°

Article number	Bag / Box	Type
1HNA	1 pc. / 10 pc.	HNAxHNA
1HNB	1 pc. / 1 pc.	HNBxHNB

Type: 9HN



T-piece
T-stuk
Pièce en T
T-Stuck

Article number	Bag / Box	Type
9HNA	1 pc. / 7 pc.	HNAxHNAxHNA
9HNB	1 pc. / 1 pc.	HNBxHNBxHNB

Type: 16HN



Reducing coupling
Verloopstuk
Réduction
Kupplung-reduziert

Article number	Bag / Box	Type
16HNBA	1 pc. / 15 pc.	HNBxHNA

Type: 27HN



Elbow 45°
Bocht 45°
Coude 45°
Winkel 45°

Article number	Bag / Box	Type
27HNA	1 pc. / 15 pc.	HNAxHNA
27HNB	1 pc. / 1 pc.	HNBxHNB

Type: 8HN



Pressfitting
Persfitting
Raccord à sertir
Pressfitting

Article number	Bag / Box	Type
■ 8HNA-PK32	1 pc. / 20 pc	HNAx32
8HNA-PK40	1 pc. / 20 pc.	HNAx40
8HNA-PK50	1 pc. / 15 pc.	HNAx50
8HNA-PK63	1 pc. / 12 pc.	HNAx63
8HNA-PK75	1 pc. / 12 pc.	HNAx75
8HNB-PK90	1 pc. / 4 pc.	HNBx90

D. SUPER SIZES



Type: HN



Bracket set
Beugel set
Support
Bracket set

Article number	Bag / Box	Type
HNA	1 pc. / 1 pc.	
HNB	1 pc. / 1 pc.	

Type: HN-PEN



Locking pin
Beugelpin
Goupille de verrouillage
Sicherungsstift

Article number	Bag / Box	Type
HN-PEN	50 pc. / 50 pc.	

Type: HN-U



Sealing ring
Dichtingsring
Anneau d'étanchéité
Dichtungsring

Article number	Bag / Box	Type
HNA-U	10 pc. / 10 pc.	HNA
HNB-U	10 pc. / 10 pc.	HNB

Type: 17HN (CW617)



Brass adapter male
Messing adapter buitendraad
Raccord en laiton mâle
Brass adapter male

Article number	Bag / Box	Type
17HNA-10	1 pc. / 22 pc.	HNAx2"
17HNA-12	1 pc. / 18 pc.	HNAx2,5"

Type: 17HN-N (CW602)



Brass adapter male
Messing adapter buitendraad
Raccord en laiton mâle
Brass adapter male

Article number	Bag / Box	Type
17HNA-10-N	1 pc. / 22 pc.	HNAx2"
17HNA-12-N	1 pc. / 18 pc.	HNAx2,5"

- 1
- 2
- 3
- 4
- 5
- 6
- 7
- 8
- 9
- 10
- 11

D. SUPER SIZES

Type: 18HN (CW617)



Brass adapter female
Messing adapter binnendraad
Raccord en laiton femelle
Brass adapter female

Article number	Bag / Box	Type
18HNA-06	1 pc. / 40 pc.	HNAx1"
18HNA-10	1 pc. / 27 pc.	HNAx2"
18HNA-12	1 pc. / 16 pc.	HNAx2,5"
18HNB-14	1 pc. / 12 pc.	HNBx3"

Type: 18HN-N (CW602)



Brass adapter female
Messing adapter binnendraad
Raccord en laiton femelle
Brass adapter female

Article number	Bag / Box	Type
18HNA-06-N	1 pc. / 40 pc.	HNAx1"
18HNA-10-N	1 pc. / 27 pc.	HNAx2"
18HNA-12-N	1 pc. / 16 pc.	HNAx2,5"
18HNB-14-N	1 pc. / 12 pc.	HNBx3"

Type: HN-STOP



Stop end for Super Size range
Eindstop voor Super Size gamma
Bouchon d'arrêt Super Size
Endkappe für das Sortiment Super Size

Article number	Bag / Box	Type
HNA-STOP	1 pc. / 90 pc.	HNA
HNB-STOP	1 pc. / 40 pc.	HNB

Type: HNA-EK05



Adapter HNA x EK 3/4"
Overgang HNA x EK 3/4"
Réduction HNA x EK 3/4"
Übergang HNA x EK 3/4"

Article number	Bag / Box	Type
HNA-EK05	1 pc. / 50 pc.	HNA x 3/4" EK



Type: HNA-ECOLINE-SET



Basic set for Inliner
 Basisset voor Inliner
 Set de base pour Inliner
 Grundsatz für Inliner

Article number	Bag / Box	Type
HNA-ECOLINE-SET	1 pc. / -	

Compostion:
 1x 9HNA (T-piece)
 4x HNA (Bracket set)
 1x HNA-EK05 (Adapter HNA-EK)
 1x HNA-INLB (Base plate for inliner)

- 1
- 2
- 3
- 4
- 5
- 6
- 7
- 8
- 9
- 10
- 11

The Henco ECO-line is an energy saving solution for recirculation loops, which limits heat loss between supply and return pipe.

A separate pipe for the circulation water is no longer required.

Designed on the Henco Super Size concept, it also combines modularity and easy installation.

ONE CONCEPT FOR ALL DIMENSIONS FROM 40 UP TO 75MM

- Cost effective
- Easy installation
- Less space consumption
- Anti legionellosis

Necessary items to complete the ECOLINE installation *

Article number	Description	Page
8HNA-PK...	Press fitting 40, 50, 63 or 75	50
100-MXC1620	Henco 1L PE-Xc 16x2 - 100m	-
19P-1605	Nickel plated press-fit adapter to eurocone 16x3/4"	73
19P-2005	Nickel plated press-fit adapter to eurocone 20x3/4"	73
33P-1605	Nickel plated press-fit adapter to eurocone 90°	74
19PK-1605	Press fit swivel to eurocone 16x3/4"	31
19PK-2005	Press fit swivel to eurocone 20x3/4"	31
19SK-1605	Push fitting with eurocone connection 16x3/4"	59
19SK-2005	Push fitting with eurocone connection 20x3/4"	59



* To complete the Ecoline installation you need to have a circulator and thermostatic balancing valve (not in Henco range)



	<i>Page</i>
A. SK	55
B. MANIFOLDS	61



Type: 1SK



Elbow 90°
Knie 90°
Coude 90°
Winkel 90°

Article number	Bag / Box	Type
1SK-1616	10 pc. / 70 pc.	16x16
1SK-2020	10 pc. / 50 pc.	20x20
1SK-2626	5 pc. / 40 pc.	26x26

Type: 2SK



Backplate elbow female
Sanitair muurplaat binnendraad
Culasse pour sanitaire femelle
Sanitär Wandscheibe IG

Article number	Bag / Box	Type
2SK-1604BP*	10 pc. / 40 pc.	16x1/2" (56 mm)
2SK-2004BP*	10 pc. / 40 pc.	20X1/2" (56 mm)
2SK-2005	10 pc. / 30 pc.	20X3/4" (56 mm)
2SK-2605	5 pc. / 20 pc.	26X3/4" (56 mm)

* With black plug BP04 1/2"

Type: 2S



Backplate elbow female, short model
Sanitair muurplaat binnendraad kort
Culasse pour sanitaire femelle, modèle court
Sanitär Wandscheibe IG, kurzes Modell

Article number	Bag / Box	Type
2S-1604K	10 pc. / 50 pc.	16x1/2" (43 mm)

Type: 3SK



Double backplate elbow female, short model
Dubbel sanitair muurplaat binnendraad, laag
Culasse double pour sanitaire, modèle court
Sanitär Wandscheibe doppelt IG, kurzes Modell

Article number	Bag / Box	Type
3SK-160416BP *	10 pc. / 30 pc.	16X1/2" (40 mm)
3SK-200420BP *	10 pc. / 30 pc.	20X1/2" (40 mm)

* With black plug BP04 1/2"

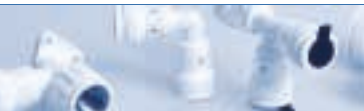

A. SK

Type: 5SK



PK-TOOL p 164

Bend 90° male adapter
Knie 90° buitendraad
Coude 90° mâle
Winkel 90° AG

Article number	Bag / Box	Type
5SK-1604	10 pc. / 60 pc.	16X1/2"
5SK-2004	10 pc. / 50 pc.	20X1/2"
5SK-2005	10 pc. / 40 pc.	20X3/4"
5SK-2605	5 pc. / 30 pc.	26X3/4"

Type: 6SK



PK-TOOL p 164

Bend 90° female adapter
Knie 90° binnendraad
Coude 90° femelle
Winkel 90° IG

Article number	Bag / Box	Type
6SK-1604BP *	10 pc. / 60 pc.	16X1/2"
6SK-2004BP *	10 pc. / 60 pc.	20X1/2"
6SK-2005	10 pc. / 30 pc.	20X3/4"
6SK-2605	10 pc. / 30 pc.	26X3/4"

* With black plug BP04 1/2"

Type: 9SK



T-piece
T-stuk
Pièce en T
T-Stuck

Article number	Bag / Box	Type
9SK-161616	10 pc. / 40 pc.	16x16x16
9SK-202020	10 pc. / 30 pc.	20x20x20
9SK-262626	5 pc. / 20 pc.	26x26x26

Type: 10SK



T-reduced centre
T-verlopend
Pièce en T réduit
T-reduziert

Article number	Bag / Box	Type
10SK-201620	10 pc. / 40 pc.	20x16x20
10SK-261626	5 pc. / 25 pc.	26x16x26
10SK-262026	5 pc. / 20 pc.	26x20x26



Type: 11SK



T-branch and line reduced
T-2X verlopemd
Pièce en T 2X réduit
T-2X reduziert

Article number	Bag / Box	Type
11SK-201616	10 pc. / 40 pc.	20x16x16
11SK-202016	10 pc. / 30 pc.	20x20x16
11SK-261620	5 pc. / 25 pc.	26x16x20
11SK-262016	5 pc. / 25 pc.	26x20x16
11SK-262020	5 pc. / 25 pc.	26x20x20
11SK-262616	5 pc. / 25 pc.	26x26x16
11SK-262620	5 pc. / 20 pc.	26x26x20

Type: 12SK



T-enlarged branch
T-vergroot
Pièce en T agrandi
T-erweitert

Article number	Bag / Box	Type
12SK-162016	10 pc. / 40 pc.	16x20x16
12SK-202620	5 pc. / 30 pc.	20x26x20

Type: 13SK



PK-TOOL p 164

T-female centre
T-binnendraad
Pièce en T femelle
T-IG

Article number	Bag / Box	Type
13SK-160416BP *	10 pc. / 40 pc.	16x1/2"x16
13SK-200420BP *	10 pc. / 30 pc.	20x1/2"x20
13SK-200520	10 pc. / 30 pc.	20x3/4"x20
13SK-260420BP *	5 pc. / 20 pc.	26x1/2"x20
13SK-260426BP *	5 pc. / 20 pc.	26x1/2"x26
13SK-260526	5 pc. / 20 pc.	26x3/4"x26

* With black plug BP04 1/2"

Type: 14SK



PK-TOOL p 164

T-male centre
T-buitendraad
Pièce en T mâle
T-AG

Article number	Bag / Box	Type
14SK-160416	10 pc. / 40 pc.	16x1/2"x16
14SK-200420	10 pc. / 30 pc.	20x1/2"x20
14SK-260426	5 pc. / 20 pc.	26x1/2"x26



A. SK

Type: 15SK



Straight coupling
Doorverbinder recht
Manchon
Kupplung

Article number	Bag / Box	Type
15SK-1616	10 pc. / 70 pc.	16x16
15SK-2020	10 pc. / 60 pc.	20x20
15SK-2626	5 pc. / 30 pc.	26x26

Type: 16SK



Reducing coupling
Verloopstuk
Réduction
Kupplung-reduziert

Article number	Bag / Box	Type
16SK-2016	10 pc. / 80 pc.	20x16
16SK-2616	10 pc. / 50 pc.	26x16
16SK-2620	10 pc. / 40 pc.	26x20

Type: 17SK



PK-TOOL p 164

Straight male adapter
Recht aansluitstuk buitendraad / Puntstuk
Raccord droit mâle
Übergangsfitting AG

Article number	Bag / Box	Type
17SK-1603	10 pc. / 80 pc.	16x3/8"
17SK-1604	10 pc. / 80 pc.	16x1/2"
17SK-2004	10 pc. / 60 pc.	20x1/2"
17SK-2005	10 pc. / 60 pc.	20x3/4"
17SK-2605	10 pc. / 40 pc.	26x3/4"
17SK-2606	10 pc. / 40 pc.	26x1"

Type: 18SK



PK-TOOL p 164

Straight female adapter
Recht aansluitstuk binnendraad / Schroefbus
Raccord droit femelle
Übergangsfitting IG

Article number	Bag / Box	Type
18SK-1604	10 pc. / 80 pc.	16x1/2"
18SK-2004	10 pc. / 80 pc.	20x1/2"
18SK-2005	10 pc. / 60 pc.	20x3/4"
18SK-2605	10 pc. / 50 pc.	26x3/4"
18SK-2606	10 pc. / 40 pc.	26x1"



Type: 17SKS



Straight nipple male (brass)
Recht aansluitstuk buitendraad (messing)
Raccord droit mâle (laiton)
Übergangsfitting AG (Messing)

Article number	Bag / Box	Type
17SKS-2004	5 pc. / 150 pc.	20x1/2"
17SKS-2005	5 pc. / 150 pc.	20x3/4"
17SKS-2604	5 pc. / 100 pc.	26x1/2"
17SKS-2605	5 pc. / 100 pc.	26x3/4"

Applicable with HENCO Vision fittings & manifolds

Type: 18SKS



Straight nipple female (brass)
Recht aansluitstuk binnendraad (messing)
Raccord droit femelle (laiton)
Übergangsfitting IG (Messing)

Article number	Bag / Box	Type
18SKS-2004	5 pc. / 150 pc.	20x1/2"
18SKS-2005	5 pc. / 100 pc.	20x3/4"
18SKS-2604	5 pc. / 100 pc.	26x1/2"
18SKS-2605	5 pc. / 80 pc.	26x3/4"

Applicable with HENCO Vision fittings & manifolds

Type: 19SK



Push fitting with eurocone connection
Steekkoppeling met euroconus-aansluiting
Raccord push fit avec eurocone
Steckkupplung mit Eurokonus

Article number	Bag / Box	Type
19SK-1605	10 pc. / 80 pc.	16x3/4"
19SK-2005	10 pc. / 80 pc.	20x3/4"

Type: 26SK



Push fitting with swivel and flat sealing
Steekkoppeling met wartel en vlakke dichting
Raccord push fit avec raccord ecrou etanchéité plate
Steckkupplung mit Drehbar und flach Versiegelung

Article number	Bag / Box	Type
26SK-1605	10 pc. / 80 pc.	16x3/4"
26SK-2005	10 pc. / 80 pc.	20x3/4"



Type: SK-PIESTOP



Stop end for pipe
Eindstop voor buis
Bouchon pour tube
Endkappe für Rohre

Article number	Bag / Box	Type
SK-PIESTOP16	10 pc. / 120 pc.	16
SK-PIESTOP20	10 pc. / 80 pc.	20
SK-PIESTOP26	10 pc. / 80 pc.	26

Type: SK-STOPCLIP



Reusable stop and clip for push fit connection
Herbruikbare stop en clip passend in een steekkoppeling
Bouchon et clip réutilisables pour connection push fit
Stopfen und clip für Steckanschluss, wieder verwendbar

Article number	Bag / Box	Type
SK-STOPCLIP16	10 pc. / 120 pc.	16
SK-STOPCLIP20	10 pc. / 100 pc.	20
SK-STOPCLIP26	10 pc. / 80 pc.	26

Type: VISION SET



Vision revision set
Vision revisie set
Set de révision Vision
Vision set

Article number	Bag / Box	Type
VISION SET 16	1 pc. / 100 pc.	16
VISION SET 20	1 pc. / 90 pc.	20
VISION SET 26	1 pc. / 80 pc.	26

Type: VISION KEY



Vision disassembly key
Vision demontage sleutel
Clé de démontage Vision
Vision Entriegelungsschlüssel

Article number	Bag / Box	Type
VISION-KEY16	1 pc. / 200 pc.	16
VISION-KEY20	1 pc. / 200 pc.	20
VISION-KEY26	1 pc. / 200 pc.	26

B. MANIFOLDS



Type: VSK-1616



Extension or body for manifold, two SK connections Ø16
Verlengstuk of basis voor verdeler, twee SK-aansluitingen Ø16
Complément ou base collecteur, deux sorties SK Ø16
Erweiterung oder Basiskörper für Verteiler, zwei SK-Anschlüssen Ø16

Article number	Bag / Box	Type
VSK-1616	1 pc. / 14 pc.	1616

Type: VSK-161616



Extension or body for manifold, three SK connections Ø16
Verlengstuk of basis voor verdeler, drie SK-aansluitingen Ø16
Complément ou base collecteur, trois sorties SK Ø16
Erweiterung oder Basiskörper für Verteiler, drei SK-Anschlüssen Ø16

Article number	Bag / Box	Type
VSK-161616	1 pc. / 14 pc.	161616

Type: VSKEK-0502



Extension or body for manifold, two eurocone connections
Verlengstuk of basis voor verdeler, twee euroconus-aansluitingen
Complément ou base collecteur, deux sorties eurocone
Erweiterung oder Basiskörper für Verteiler, zwei Eurokonus-Anschlüssen

Article number	Bag / Box	Type
VSKEK-0502	10 pc. / 30 pc.	2x3/4"

Type: VSKEK-0503



Extension or body for manifold, three eurocone connections
Verlengstuk of basis voor verdeler, drie euroconus-aansluitingen
Complément ou base collecteur, trois sorties eurocone
Erweiterung oder Basiskörper für Verteiler, drei Eurokonus-Anschlüssen

Article number	Bag / Box	Type
VSKEK-0503	10 pc. / 30 pc.	3x3/4"

- 1
- 2
- 3
- 4
- 5
- 6
- 7
- 8
- 9
- 10
- 11

B. MANIFOLDS

Type: 19SK



Push fitting with eurocone connection
 Steekkoppeling met euroconus-aansluiting
 Raccord push fit avec eurocone
 Steckkupplung mit Eurokonus

Article number	Bag / Box	Type
19SK-1605	10 pc. / 80 pc.	16x3/4"
19SK-2005	10 pc. / 80 pc.	20x3/4"

Type: VVSK



Straight entry piece
 Voeding voor verdeler
 Départ collecteur
 Eingang für Verteiler

Article number	Bag / Box	Type
VVSK-20	10 pc. / 80 pc.	20
VVSK-26	10 pc. / 80 pc.	26

Type: VVSK-TM



T-piece for supply for Vision manifold
 Aanvoer T-stuk voor Vision manifold
 Départ pièce en T collecteur Vision
 T-Stück für Vorlauf für Vision Verteiler

Article number	Bag / Box	Type
VVSK-T20M20	10 pc. / 30 pc.	20-20
VVSK-T26M26	5 pc. / 20 pc.	26-26

Type: 17SKS



Straight nipple male (brass)
 Recht aansluitstuk buitendraad (messing)
 Raccord droit mâle (laition)
 Übergangsfitting AG (Messing)

Article number	Bag / Box	Type
17SKS-2004	5 pc. / 150 pc.	20 x 1/2"
17SKS-2005	5 pc. / 150 pc.	20 x 3/4"
17SKS-2604	5 pc. / 100 pc.	26 x 1/2"
17SKS-2605	5 pc. / 100 pc.	26 x 3/4"

Applicable with HENCO Vision fittings & manifolds

B. MANIFOLDS



Type: 18SKS



Straight nipple female (brass)
 Recht aansluitstuk binnendraad (messing)
 Raccord droit femelle (laiton)
 Übergangsfitting IG (Messing)

Article number	Bag / Box	Type
18SKS-2004	5 pc. / 150 pc.	20 x 1/2"
18SKS-2005	5 pc. / 100 pc.	20 x 3/4"
18SKS-2604	5 pc. / 100 pc.	26 x 1/2"
18SKS-2605	5 pc. / 80 pc.	26 x 3/4"

Applicable with HENCO Vision fittings & manifolds

Type: VVSK-90



Elbow 90° for manifold
 Knie 90° voor verdeler
 Coude 90° pour collecteur
 Winkel 90° für Verteiler

Article number	Bag / Box	Type
VVSK-20-90	10 pc. / 70 pc.	20-90
VVSK-26-90	10 pc. / 50 pc.	26-90

Type: VVSK-T



T for manifold
 T voor verdeler
 Piece en T pour collecteur
 T für Verteiler

Article number	Bag / Box	Type
VVSK-T202020	10 pc. / 40 pc.	20-20-20
VVSK-T262626	10 pc. / 20 pc.	26-26-26

Type: VS-ENDCAP



Endcap female for manifold
 Eindkap binnendraad voor verdeler
 Bouchon femelle pour collecteur
 Endkappe IG für Verteiler

Article number	Bag / Box	Type
VS-ENDCAP	10 pc. / 180 pc.	F



B. MANIFOLDS

Type: VS-ENDCAP-M



End plugmale for manifold
Eindstop buitendraad voor verdeler
Bouchon mâle pour collecteur
Endkappe AG für Verteiler

Article number	Bag / Box	Type
VS-ENDCAP-M	10 pc. / 150 pc.	M

Type: ENDCAP-EK05



Eurocone endcap 3/4" white
Euroconus-eindkap 3/4" wit
Eurocone bouchon 3/4" blanc
Eurokonus Endkappe 3/4" Weiss

Article number	Bag / Box	Type
ENDCAP-EK05	10 pc. / 200 pc.	3/4"

Type: VDSK



Straight female adapter for manifold or manifold extension
Doorverbinder voor montage op verdeler of verlengstuk
Manchon pour bout de collecteur
Ausgang für Verteiler

Article number	Bag / Box	Type
VDSK-20	10 pc. / 80 pc.	20
VDSK-26	10 pc. / 60 pc.	26

Type: SK-STOPCLIP



Reusable stop and clip for push fit connection
Herbruikbare stop en clip passend in een steekkoppeling
Bouchon et clip réutilisables pour connection push fit
Stopfen und clip für Steckanschluss, wieder verwendbar

Article number	Bag / Box	Type
SK-STOPCLIP16	10 pc. / 120 pc.	16
SK-STOPCLIP20	10 pc. / 100 pc.	20
SK-STOPCLIP26	10 pc. / 80 pc.	26

Type: SK-B05



Bracket for Vision manifolds
Montagebeugel voor Vision verdelers
Double support pour collecteurs Vision
Halter für Vision Verteiler

Article number	pc / Box	Typ
SK-B05	1 pc. / 200 pc.	B05

B. MANIFOLDS



POSSIBLE COMBINATIONS

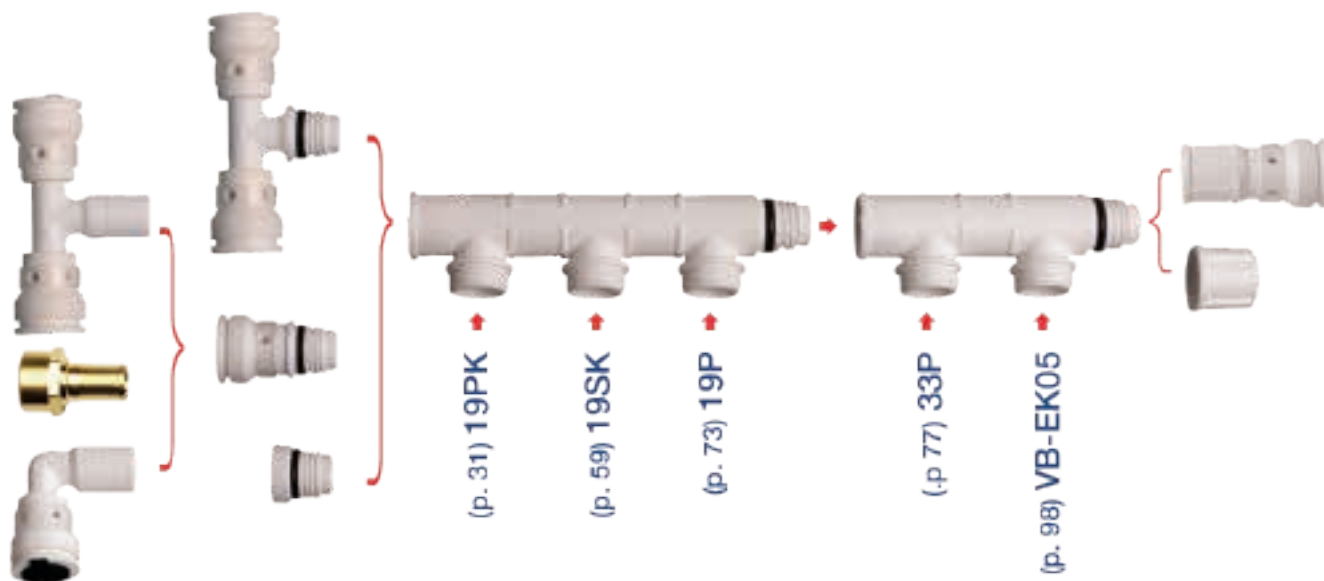

- 1
- 2
- 3
- 4
- 5
- 6
- 7
- 8
- 9
- 10
- 11

Type: 41S



Brass Vision coupling with valve F-connection
 Messing Vision koppeling met F-aansluiting
 Connecteur Vision F
 Vision Fitting mit F-Verbindung

Article number	Bag / Box	Typ
41S-20	10 pc. / 60 pc.	20
41S-26	10 pc. / 80 pc.	26

Type: 41SKS



Connection Vision coupling with valve F-connection
 Aansluitstuk Vision koppeling met F-aansluiting
 Raccord Vision Connecteur Vision F
 Messing Übergang Vision Fitting mit F-Verbindung

Article number	Bag / Box	Typ
41SKS-20	10 pc. / 80 pc.	20
41SKS-26	10 pc. / 80 pc.	26

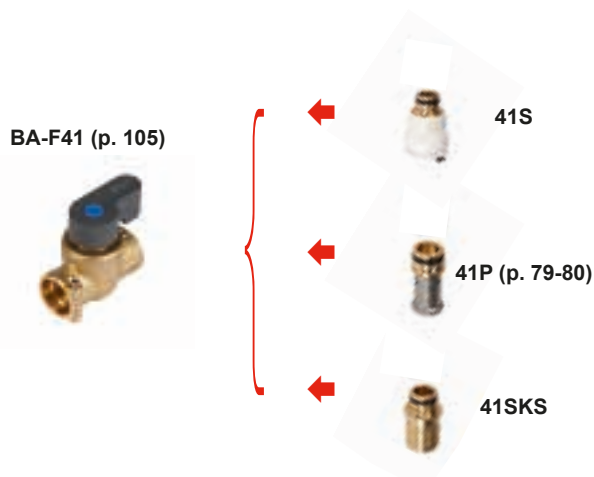

BRASS PRESS FITTINGS - MESSING PERSKOPPELINGEN - RACCORDS À SERTIR EN LAITON - MESSING PRESSFITTINGE



	<i>Page</i>
<i>A. P</i>	<i>67</i>
<i>B. PG</i>	<i>81</i>



Type: 1P



Elbow 90°
Knie 90°
Coude 90°
Winkel 90°

Article number	Bag / Box	Type
1P-1414	10 pc. / 150 pc.	14x14
1P-1616	10 pc. / 150 pc.	16x16
1P-1818	10 pc. / 100 pc.	18x18
1P-2020	10 pc. / 80 pc.	20x20
1P-2626	5 pc. / 50 pc.	26x26

Type: 2P



Backplate elbow female
Sanitair muurplaat binnendraad
Culasse pour sanitaire femelle
Sanitär Wandscheibe IG

Article number	Bag / Box	Type
2P-1604	10 pc. / 50 pc.	16x1/2" (52 mm)
2P-1804	10 pc. / 50 pc.	18x1/2" (52 mm)
2P-2004	10 pc. / 50 pc.	20x1/2" (52 mm)
2P-2005	10 pc. / 50 pc.	20x3/4" (52 mm)
2P-2605	5 pc. / 50 pc.	26x3/4" (52 mm)

Type: 2P-K



Backplate elbow female, short model
Sanitair muurplaat binnendraad, laag
Culasse pour sanitaire femelle, modèle court
Sanitär Wandscheibe IG, kurzes Modell

Article number	Bag / Box	Type
2P-1404K	10 pc. / 50 pc.	14x1/2" (35 mm)
2P-1604K	10 pc. / 50 pc.	16x1/2" (35 mm)

Accessory 2P & 2P-K: galvanised bracket plate - see page 168



PLP-P-PK



PLF-P-PK

Type: 3P



Double backplate elbow female
Sanitaire muurplaat binnendraad, dubbel
Culasse double pour sanitaire femelle
Sanitär Wandscheibe doppelt IG

Article number	Bag / Box	Type
3P-160416	10 pc. / 40 pc.	16x1/2"x16 (52 mm)
3P-200420	10 pc. / 40 pc.	20x1/2"x20 (52 mm)

- 1
- 2
- 3
- 4
- 5
- 6
- 7
- 8
- 9
- 10
- 11

Type: 3P-VK



Double backplate female (flow), short model
 Doorstroom muurplaat binnendraad, laag
 Culasse double femelle (écoulement), modèle court
 Wandscheibe doppelt IG (Fluss), kurzes Modell

Article number	Bag / Box	Type
3P-160416VK	5 pc. / 20 pc.	16x1/2"x16 (40 mm)
3P-200420VK	5 pc. / 20 pc.	20x1/2"x20 (40 mm)

Type: 4P



Backplate elbow female, extended model
 Sanitair muurplaat binnendraad, hoog
 Culasse pour sanitaire femelle, modèle long
 Sanitär Wandscheibe IG, langes Modell

Article number	Bag / Box	Type
4P-1604	10 pc. / 40 pc.	16x1/2" (78 mm)
4P-1804	10 pc. / 40 pc.	18x1/2" (78 mm)
4P-2004	10 pc. / 40 pc.	20x1/2" (78 mm)

Accessory 3P-VK & 4P : galvanised bracket plate - see page 168



PLP-P-PK



PLF-P-PK

Type: 5P



Bend 90° male adapter
 Knie 90° buitendraad
 Coude 90° mâle
 Winkel 90° AG

Article number	Bag / Box	Type
5P-1404	10 pc. / 150 pc.	14x1/2"
5P-1603	10 pc. / 150 pc.	16x3/8"
5P-1603DZR *	10 pc. / 150 pc.	16x3/8"
5P-1604	10 pc. / 150 pc.	16x1/2"
5P-1604DZR *	10 pc. / 150 pc.	16x1/2"
5P-1804	10 pc. / 120 pc.	18x1/2"
5P-2004	10 pc. / 100 pc.	20x1/2"
5P-2005	10 pc. / 80 pc.	20x3/4"
5P-2605	10 pc. / 60 pc.	26x3/4"
5P-3206 **	5 pc. / 25 pc.	32x1"

* DZR = Brass alloy CW602N"

**TILL EXHAUSTION OF STOCK



Type: 6P



Bend 90° female adapter
Knie 90° binnendraad
Coude 90° femelle
Winkel 90° IG

Article number	Bag / Box	Type
6P-1404	10 pc. / 120 pc.	14x1/2"
6P-1604	10 pc. / 120 pc.	16x1/2"
6P-1804	10 pc. / 120 pc.	18x1/2"
6P-2004	10 pc. / 120 pc.	20x1/2"
6P-2005	10 pc. / 50 pc.	20x3/4"
6P-2605	5 pc. / 50 pc.	26x3/4"

*TILL EXHAUSTION OF STOCK

Type: 7P



Backplate elbow male
Sanitair muurplaat buitendraad met binnendraad 1/2"
Culasse pour sanitaire mâle
Sanitär Wandscheibe AG

Article number	Bag / Box	Type
7P-1605	10 pc. / 30 pc.	16x3/4" (78 mm)
7P-2005	10 pc. / 30 pc.	20x3/4" (78 mm)

Type: 8P



Sanitary adapter female
Sanitair aansluitstuk met binnendraad
Culasse pour sanitaire femelle
UP-Spülkastenwinkel

Article number	Bag / Box	Type
8P-1604	10 pc. / 50 pc.	16x1/2"

Type: 9P



T-piece
T-stuk
Piece en T
T-Stück

Article number	Bag / Box	Type
9P-141414	10 pc. / 100 pc.	14x14x14
9P-161616	10 pc. / 60 pc.	16x16x16
9P-181818	10 pc. / 60 pc.	18x18x18
9P-202020	10 pc. / 50 pc.	20x20x20
9P-262626	5 pc. / 30 pc.	26x26x26
9P-323232 *	1 pc. / 20 pc.	32x32x32

*TILL EXHAUSTION OF STOCK

Type: 10P



T-reduced centre

T-verlopend

Pièce en T réduit

T-reduziert

Article number	Bag / Box	Type
10P-161416	10 pc. / 50 pc.	16x14x16
10P-181618	10 pc. / 60 pc.	18x16x18
10P-201620	10 pc. / 50 pc.	20x16x20
10P-201820	10 pc. / 50 pc.	20x18x20
10P-261626	5 pc. / 30 pc.	26x16x26
10P-261826	5 pc. / 30 pc.	26x18x26
10P-262026	5 pc. / 30 pc.	26x20x26
10P-321632 *	5 pc. / 20 pc.	32x16x32
10P-322032 *	5 pc. / 20 pc.	32x20x32
10P-322632 *	5 pc. / 20 pc.	32x26x32

*TILL EXHAUSTION OF STOCK

Type: 11P



T-branch and line reduced

T-2X verlopend

Pièce en T 2X réduit

T-2X reduziert

Article number	Bag / Box	Type
11P-181616	10 pc. / 50 pc.	18x16x16
11P-201616	10 pc. / 50 pc.	20x16x16
11P-201818	10 pc. / 50 pc.	20x18x18
11P-202016	10 pc. / 50 pc.	20x20x16
11P-261620	5 pc. / 30 pc.	26x16x20
11P-262020	5 pc. / 30 pc.	26x20x20
11P-262616	5 pc. / 30 pc.	26x26x16
11P-262620	5 pc. / 30 pc.	26x26x20
11P-322026 *	5 pc. / 20 pc.	32x20x26
11P-322626 *	5 pc. / 20 pc.	32x26x26

*TILL EXHAUSTION OF STOCK

Type: 12P



T-enlarged branch

T-vergroot

Pièce en T agrandi

T-erweitert

Article number	Bag / Box	Type
12P-161816	10 pc. / 60 pc.	16x18x16
12P-162016	10 pc. / 60 pc.	16x20x16
12P-202620	5 pc. / 30 pc.	20x26x20
12P-263226 *	5 pc. / 20 pc.	26x32x26

*TILL EXHAUSTION OF STOCK



Type: 13P



T-with female branch

T-binnendraad

Pièce en T femelle

T-IG

Article number	Bag / Box	Type
13P-160416	10 pc. / 60 pc.	16x1/2"x16
13P-200420	10 pc. / 50 pc.	20x1/2"x20
13P-200520	10 pc. / 30 pc.	20x3/4"x20
13P-260426	5 pc. / 30 pc.	26x1/2"x26
13P-260526	5 pc. / 30 pc.	26x3/4"x26
13P-320532 *	5 pc. / 20 pc.	32x3/4"x32
13P-320632 *	5 pc. / 20 pc.	32x1"x32
13P-320732 *	5 pc. / 20 pc.	32x1 1/4"x32

*TILL EXHAUSTION OF STOCK

Type: 14P



T-with male branch

T-buitendraad

Pièce en T mâle

T-AG

Article number	Bag / Box	Type
14P-160416	10 pc. / 60 pc.	16x1/2"x16
14P-200420	10 pc. / 60 pc.	20x1/2"x20
14P-200520	5 pc. / 30 pc.	20x3/4"x20
14P-260426	5 pc. / 30 pc.	26x1/2"x26
14P-260526	5 pc. / 30 pc.	26x3/4"x26
14P-260626	5 pc. / 30 pc.	26x1"x26
14P-320532 *	5 pc. / 20 pc.	32x3/4"x32
14P-320632 *	5 pc. / 20 pc.	32x1"x32

*TILL EXHAUSTION OF STOCK

Type: 15P



Straight coupling

Doorverbinder recht / perssok

Manchon

Kupplung

Article number	Bag / Box	Type
15P-1414	10 pc. / 200 pc.	14x14
15P-1616	10 pc. / 200 pc.	16x16
15P-1818	10 pc. / 150 pc.	18x18
15P-2020	10 pc. / 140 pc.	20x20
15P-2626	5 pc. / 80 pc.	26x26
15P-3232 *	5 pc. / 50 pc.	32x32

*TILL EXHAUSTION OF STOCK

Type: 16P



Reducing coupling
Verloopstuk
Réduction
Kupplung-reduziert

Article number	Bag / Box	Type
16P-1614	10 pc. / 150 pc.	16x14
16P-1816	10 pc. / 150 pc.	18x16
16P-2016	10 pc. / 150 pc.	20x16
16P-2018	10 pc. / 150 pc.	20x18
16P-2616	5 pc. / 100 pc.	26x16
16P-2620	5 pc. / 80 pc.	26x20
16P-3216 *	5 pc. / 60 pc.	32x16
16P-3220 *	5 pc. / 60 pc.	32x20
16P-3226 *	5 pc. / 60 pc.	32x26

**TILL EXHAUSTION OF STOCK*

Type: 17P



Straight male adapter
Recht aansluitstuk buitendraad / Puntstuk
Raccord droit mâle
Übergangsfitting AG

Article number	Bag / Box	Type
17P-1403	10 pc. / 250 pc.	14x3/8"
17P-1404	10 pc. / 150 pc.	14x1/2"
17P-1603	10 pc. / 150 pc.	16x3/8"
17P-1603DZR	10 pc. / 150 pc.	16x3/8"
17P-1604	10 pc. / 150 pc.	16x1/2"
17P-1604DZR	10 pc. / 150 pc.	16x1/2"
17P-1605	10 pc. / 150 pc.	16x3/4"
17P-1804	10 pc. / 150 pc.	18x1/2"
17P-1805	10 pc. / 150 pc.	18x3/4"
17P-2004	10 pc. / 150 pc.	20x1/2"
17P-2005	10 pc. / 150 pc.	20x3/4"
17P-2605	5 pc. / 80 pc.	26x3/4"
17P-2606	5 pc. / 80 pc.	26x1"
17P-3207 *	5 pc. / 40 pc.	32x1 1/4"

**TILL EXHAUSTION OF STOCK*

**Type: 18P**

Straight female adapter
Recht aansluitstuk binnendraad / Schroefbus
Raccord droit femelle
Übergangsfitting IG

Article number	Bag / Box	Type
18P-1404	10 pc. / 200 pc.	14x1/2"
18P-1604	10 pc. / 150 pc.	16x1/2"
18P-1804	10 pc. / 120 pc.	18x1/2"
18P-1805	10 pc. / 100 pc.	18x3/4"
18P-2004	10 pc. / 100 pc.	20x1/2"
18P-2005	10 pc. / 100 pc.	20x3/4"
18P-2605	5 pc. / 80 pc.	26x3/4"
18P-2606	5 pc. / 70 pc.	26x1"
18P-3207 *	5 pc. / 30 pc.	32x1 1/4"

**TILL EXHAUSTION OF STOCK*

Type: 19P

Press-fit adapter to eurocone
Aansluiting met wartel en euroconus-koppeling
Raccordement avec raccord à visser eurocone
Anschlussverschraubung mit Eurokonus

Article number	Bag / Box	Type
19P-1605	10 pc. / 150 pc.	16x3/4"
19P-1805	10 pc. / 150 pc.	18x3/4"
19P-2005	10 pc. / 140 pc.	20x3/4"

Type: 20P

Fitting short model for plint-heating
Fitting laag model voor plintverwarming
Raccord pour montage dans la plinthe
Sockelleisten- Anschluss-Set kurz von unten

Article number	Bag / Box	Type
20P-1604	2 pc. / 10 pc.	16x1/2"

TILL EXHAUSTION OF STOCK

Type: 21P

Elbow for plinth-heating chrome-plated
Bocht voor plintverwarming verchromd
Equerre chromée pour montage dans la plinthe
Sockelleistenanschluss Winkel verchromt

Article number	Bag / Box	Type
21P-1504	2 pc. / 40 pc.	15x1/2"

Type: 22P



T, radiator connection nickel-plated 300 mm copper pipe Ø15
 Radiatoraansluiting T vernikkeld met 300 mm koperbuis Ø15
 T, alimentation radiateur nickelé 300 mm tube de cuivre Ø15
 Heizkörperanschlusss T vernickelt 300 mm Kupferrohr Ø15

Article number	Bag / Box	Type
22P-1604	2 pc. / 50 pc.	16x15Cux16
22P-2004	2 pc. / 30 pc.	20x15Cux20

Type: 24P



Radiator connection nickel-plated 300 mm copper pipe Ø15
 Radiatoraansluitbocht vernikkeld met 300 mm koperbuis Ø15
 Alimentation radiateur nickelé 300 mm tube de cuivre Ø15
 Heizkörperanschluss vernickelt 300 mm Kupferrohr Ø15

Article number	Bag / Box	Type
24P-1604	2 pc. / 50 pc.	16x15Cu
24P-2004	2 pc. / 50 pc.	20x15Cu

Type: 25P



Radiator connection nickel-plated 1100 mm copper pipe Ø15
 Radiatoraansluitbocht vernikkeld met 1100 mm koperbuis Ø15
 Alimentation radiateur nickelé 1100 mm tube de cuivre Ø15
 Heizkörperanschluss vernickelt 1100 mm Kupferrohr Ø15

Article number	Tasche	Type
25P-1604	2 pc.	16x15Cu
25P-2004	2 pc.	20x15Cu

Type: 26P



Union with flat seat
 3-delige koppeling vlak dichtend
 Raccord union à joint plat
 Verschraubung flachdichtend

Article number	Bag / Box	Type
26P-1604	10 pc. / 100 pc.	16x1/2"
26P-1605	10 pc. / 80 pc.	16x3/4"
26P-2004	10 pc. / 80 pc.	20x1/2"
26P-2005	10 pc. / 70 pc.	20x3/4"
26P-2605	5 pc. / 50 pc.	26x3/4"
26P-2606	5 pc. / 40 pc.	26x1"
26P-3206	5 pc. / 40 pc.	32x1"



Type: 26P-Z



Press fitting swivel adapter
 Aansluiting met wartel, vlakke dichting
 Raccord à visser, joint plat
 Pressfitting mit IG flachdichtend ohne Nippel

Article number	Bag / Box	Type
26P-14Z04	10 pc. / 150 pc.	14x1/2"
26P-16Z03	10 pc. / 150 pc.	16x3/8"
26P-16Z04	10 pc. / 150 pc.	16x1/2"
26P-16Z05	10 pc. / 80 pc.	16x3/4"
26P-18Z05	10 pc. / 80 pc.	18x3/4"
26P-20Z04	10 pc. / 150 pc.	20x1/2"
26P-20Z05	10 pc. / 70 pc.	20x3/4"
26P-26Z05	5 pc. / 50 pc.	26x3/4"
26P-26Z06	5 pc. / 40 pc.	26x1"
26P-32Z06	5 pc. / 40 pc.	32x1"
26P-32Z07	5 pc. / 40 pc.	32x1 1/4"

Type: N



Nipple for 26P-Z
 Nippel voor 26P-Z
 Nipple pour 26P-Z
 Nippel für 26P-Z

Article number	Bag / Box	Type
N04	10 pc. / 250 pc.	1/2"x3/4"
N05	10 pc. / 200 pc.	3/4"x3/4"

Type: 27P



45° bend
 Bocht 45°
 Coude 45°
 Winkel 45°

Article number	Bag / Box	Type
27P-2626	5 pc. / 50 pc.	26x26
27P-3232	5 pc. / 30 pc.	32x32

Type: 28P



Double backplate elbow female, build-up
 Dubbele muurplaat binnendraad, opbouw
 Culasse double pour sanitaire femelle
 Sanitär Wandscheibe doppelt IG, Oberbau

Article number	Bag / Box	Type
28P-14041604-1	1 pc. / 20 pc.	14x1/2"x16x1/2" (153 mm)
28P-16041604-1	1 pc. / 20 pc.	16x1/2"x16x1/2" (153 mm)

- 1
- 2
- 3
- 4
- 5
- 6
- 7
- 8
- 9
- 10
- 11

Type: 28PV



Double backplate elbow female, build-in
 Dubbele muurplaat binnendraad, inbouw
 Culasse double surélevé
 Wandwinkel doppelt erhöht

Article number	Bag / Box	Type
28PV-16031603-1	1 pc. / 15 pc.	16x3/8"x16x3/8" (120 mm)
28PV-16041604-1	1 pc. / 15 pc.	16x1/2"x16x1/2" (153 mm)

Type: 28PF



Double backplate elbow female for plaster
 Dubbel muurplaat binnendraad voor gips
 Culasse double femelle pour plâtre
 Wandscheibe doppelt IG für Gips

Article number	Bag / Box	Type
28PF-16041604	1 pc. / 1 pc.	16x1/2"x16x1/2"
28PF-20042004	1 pc. / 1 pc.	20x1/2"x20x1/2"

Type: 29P-CS (CW724)

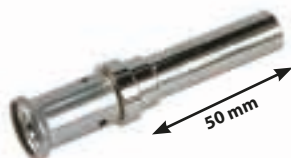

Press-fit adapter with copper pipe
 Persfitting verlengd met koperbuis
 Manchon à sertir avec tube en cuivre
 Pressfitting mit Kupferrohr

Article number	Bag / Box	Type
29P-1612-CS	10 pc. / 120 pc.	16x12 (50mm copper)
29P-1615-CS	10 pc. / 120 pc.	16x15 (50mm copper)
29P-2018-CS	10 pc. / 70 pc.	20x18 (50mm copper)
29P-2022-CS	10 pc. / 70 pc.	20x22 (50mm copper)
29P-2622-CS	10 pc. / 70 pc.	26x22 (50mm copper)

Type: 30P



Press-fit adapter to copper compression
 Overgangsstuk Henco pers x koperbuis knelkoppeling
 Manchon à sertir x tube en cuivre manchon à visser
 Pressfitting x Klemmverbinder für Kupferrohr

Article number	Bag / Box	Type
30P-1614S	10 pc. / 120 pc.	16x14 Cu
30P-1615S-2	2 pc. / 100 pc.	16x15 Cu
30P-2022S	10 pc. / 100 pc.	20x22 Cu
30P-2622S	10 pc. / 80 pc.	26x22 Cu

**Type: 40P**

Press-fit elbow to copper compression
 Knie Henco pers x koperbuis knelkoppeling
 Coude à sertir x tube en cuivre manchon à visser, 90°
 Winkel Henco Press x Klemmverbinder für Kupferrohr

Article number	Bag / Box	Type
40P-1615S	10 pc. / 60 pc.	16x15 Cu
40P-2022S	10 pc. / 60 pc.	20x22 Cu
40P-2622S	10 pc. / 60 pc.	26x22 Cu

Type: 31P

Double crossover tee, nickel plated
 Kruisingsvrij T-stuk, vernikkeld
 Double T croisé, étamé
 Kreuzungs-T-Stück, vernickelt

Article number	Bag / Box	Type
31P-161616	1 pc. / 20 pc.	16x16x16
31P-161620	1 pc. / 20 pc.	16x16x20
31P-201616	1 pc. / 20 pc.	20x16x16
31P-201620	1 pc. / 20 pc.	20x16x20
31P-202020	1 pc. / 20 pc.	20x20x20

Type: ISO-BOX

Insulation box for double crossover tee
 Isolatiebox voor kruisingsvrij T-Stuk
 Boîte d'isolation pour T croisé
 Isolierboxen für Kreuzungs-T-Stück

Article number	Box	Type
ISO-BOX	1 pc.	INSULATION BOX

Type: 33P

Nickel plated press-fit adapter to eurocone, 90°
 Aansluiting met wartel en euroconus-koppeling vernikkeld, 90°
 Raccord à visser eurocone nickelé, 90°
 Anschlussverschraubung mit Eurokonus vernickelt, 90°

Article number	Bag / Box	Type
33P-1605	10 pc. / 60 pc.	16x3/4"

Type: 34P



Henco press swivel adapter with flat sealing, 90°

Aansluiting met wartel vlakdichtend, 90°

Raccord à visser joint plat, 90°

Anschlussverschraubung mit AG flachdichtend, 90°

Article number	Bag / Box	Type
34P-1604	10 pc. / 120 pc.	16x1/2"
34P-1605	10 pc. / 120 pc.	16x3/4"
34P-3206	5 pc. / 40 pc.	32x1"

TILL EXHAUSTION OF STOCK

Type: 34P-CS (CW724)



Henco press swivel adapter with flat sealing, 90°

Aansluiting met wartel vlakdichtend, 90°

Raccord à visser joint plat, 90°

Anschlussverschraubung mit AG flachdichtend, 90°

Article number	Bag / Box	Type
34P-1605-CS	10 pc. / 120 pc.	16x3/4"
34P-2004-CS	10 pc. / 80 pc.	20x/2"
34P-2005-CS	10 pc. / 80 pc.	20x3/4"
34P-2605-CS	10 pc. / 70 pc.	26x3/4"

Type: 35P



Press-fit adapter to copper press (M-profile)

Overgangsstuk Henco pers naar koper pers (M-profiel)

Manchon à sertir vers cuivre à sertir (profil M)

Pressfitting Henco zu Pressfitting für Kupferrohr (M-profile)

Article number	Bag / Box	Type
35P-1615P	10 pc. / 150 pc.	16x15Cu M-profile
35P-2018P	10 pc. / 120 pc.	20x18Cu M-profile
35P-2022P	10 pc. / 80 pc.	20x22Cu M-profile
35P-3228P	5 pc. / 50 pc.	32x28Cu M-profile

TILL EXHAUSTION OF STOCK

Type: 36P (CW724)



Press-fit adapter to copper press or thin steel (V, M & SA-profile)

Overgangsstuk Henco pers naar koper pers of dunwandig staal (V, M & SA-profiel)

Manchon à sertir vers cuivre à sertir (profil M, V & SA)

Pressfitting Henco zu Pressfitting für Kupferrohr oder dünnwandig Stahl (Presskontur M, V & SA)

Article number	Bag / Box	Type
36P-1612P	10 pc. / 160 pc.	16x12Cu
36P-1614P	10 pc. / 150 pc.	16x14Cu
36P-1615P	10 pc. / 150 pc.	16x15Cu
36P-1616P	10 pc. / 150 pc.	16x16Cu
36P-2015P	10 pc. / 120 pc.	20x15Cu
36P-2018P	10 pc. / 120 pc.	20x18Cu
36P-2022P	10 pc. / 80 pc.	20x22Cu
36P-2622P	10 pc. / 70 pc.	26x22Cu
36P-3228P	5 pc. / 50 pc.	32x28Cu



Type: 37P

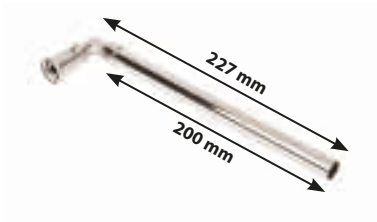

Press-fit adapter to copper pipe, elbow
 Persfitting verlengd met koperbuis, knie
 Coude à sertir avec tube en cuivre soudé
 Pressfitting mit geschweisstem Kupferrohr, Winkel

Article number	Bag / Box	Type
37P-1412L	10 pc. / 60 pc.	14x12 (227/200mm)
37P-1612L	10 pc. / 60 pc.	16x12 (227/200mm)
37P-1615L	10 pc. / 60 pc.	16x15 (227/200mm)

Type: 39P



Double bend for radiator nickel-plated 300 mm copper pipe Ø15, connected end
 Dubbele radiatorbocht koperbuis Ø15, 300 mm, vernikkeld, doorverbonden einde
 Double courbe radiateur nickelé 300 mm tube en cuivre, bout rattaché
 Doppelter Heizkörperwinkel vernickelt 300 mm Kupferrohr Ø15, durchgestelltes Ende

Article number	Bag / Box	Typ
39P-160450	1 pc. / 8 pc.	16x1/2" (AS = 50 mm)

Interaxis 50 mm

Type: 52P



Easy mounting/repair fitting
 Eenvoudige montage/reparatie fitting
 Raccord montage/réparation facile
 Einfache Montage/Reparatur Fitting

Article number	Bag / Box	Type
52P16	1 pc. / 40 pc.	16x16
52P20	1 pc. / 30 pc.	20x20
52P26	1 pc. / 30 pc.	26x26
52P32	1 pc. / 30 pc.	32x32

for Ø40, 50 and 63: chapter 2, article 53PK

Type: 41P



Brass press coupling with valve F-connection
 Messing perskoppeling met F-aansluiting
 Connecteur F à sertir
 Pressfitting mit F-Connection

Article number	Bag / Box	Type
41P-16	10 pc. / 40 pc.	16
41P-20	10 pc. / 40 pc.	20
41P-26	10 pc. / 40 pc.	26

- 1
- 2
- 3
- 4
- 5
- 6
- 7
- 8
- 9
- 10
- 11

BA-F41
(p. 105)

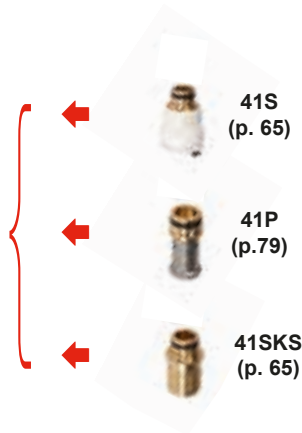

41S
(p. 65)

41P
(p.79)

41SKS
(p. 65)

Type: 42P



Straight coupling PEX
Doorverbinder recht PEX
Manchon PEX
Kupplung PEX

Article number	Bag / Box	Type
42P-161615	10 pc. / 200 pc.	16x16x15
42P-202019	10 pc. / 140 pc.	20x20x19

Type: WALL BOX



Wall box 2 pair red/blue, 1/2"FX16mm
Wall box 2 paar rood/blauw, 1/2"FX16mm
Wall box 2 paires rouge/bleu, 1/2"FX16mm
Wall box 2 Paare red/blau, 1/2"FX16mm

Article number	Bag / Box	Type
WBP-1604	1 pc. / 40 pc.	16x1/2"
WBP-2004	1 pc. / 40 pc..	20x1/2"



Instruction video



Gas: only allowed in countries where has been a HENCO GAS testing + certificate is available! (See www.henco.be)
Gas: enkel toegelaten in landen waar er een HENCO GAS keur is + certificaat voorhanden is! (Zie www.henco.be)
Gaz: seulement permis dans des pays où le contrôle a eu lieu + certificat est disponible! (Consultez www.henco.be)
Gas: nur zugelassen in Länder wo HENCO GAS Prüfung geschehen ist + Zertifikat vorhanden ist! (Siehe www.henco.be)

Henco brass press fittings for gas in combination with standard pipes gas, see page 19



Type: 1PG



Elbow 90°
Knie 90°
Coude 90°
Winkel 90°

Article number	Bag / Box	Type
1PG-1616	10 pc. / 150 pc.	16x16
1PG-2020	10 pc. / 80 pc.	20x20
1PG-2626	5 pc. / 50 pc.	26x26

Type: 2PG



Backplate elbow female
Muurplaat binnendraad
Culasse femelle
Wandscheibe IG

Article number	Bag / Box	Type
2PG-1604	10 pc. / 50 pc.	16x1/2" (52 mm)
2PG-2004	10 pc. / 50 pc.	20x1/2" (52 mm)
2PG-2005	10 pc. / 50 pc.	20x3/4" (52mm)
2PG-2605	5 pc. / 50 pc.	26x3/4" (52 mm)

Type: 2PG-K



Backplate elbow female, short model
Muurplaat binnendraad, laag
Culasse femelle, modèle court
Wandscheibe IG, kurzes Modell

Article number	Bag / Box	Type
2PG-1604K	10 pc. / 50 pc.	16x1/2" (35 mm)

Type: 3PG



Double backplate elbow female
Muurplaat binnendraad dubbel
Culasse double
Wandscheibedoppelt IG

Article number	Bag / Box	Type
3PG-160416	10 pc. / 50 pc.	16x1/2"x16 (52 mm)
3PG-200420	10 pc. / 40 pc.	20x1/2"x20 (52 mm)

Type: 5PG



Elbow 90° male adapter
 Knie 90° buitendraad
 Coude 90° mâle
 Winkel 90° AG

Article number	Bag / Box	Type
5PG-1604	10 pc. / 150 pc.	16x1/2"
5PG-2004	10 pc. / 100 pc.	20x1/2"
5PG-2005	10 pc. / 80 pc.	20x3/4"
5PG-2605	10 pc. / 60 pc.	26x3/4"

Type: 6PG



Elbow 90° female adapter
 Knie 90° binnendraad
 Coude 90° femelle
 Winkel 90° IG

Article number	Bag / Box	Type
6PG-1604	10 pc. / 120 pc.	16x1/2"
6PG-2004	10 pc. / 120 pc.	20x1/2"
6PG-2005	10 pc. / 50 pc.	20x3/4"
6PG-2605	5 pc. / 50 pc.	26x3/4"

Type: 9PG



T-piece
 T-stuk
 Pièce en T
 T-Stück

Article number	Bag / Box	Type
9PG-161616	10 pc. / 60 pc.	16x16x16
9PG-202020	10 pc. / 50 pc.	20x20x20
9PG-323232 *	1 pc. / 20 pc.	32x32x32

*TILL EXHAUSTION OF STOCK

Type: 10PG



T-reduced centre
 T-verlopend
 Pièce en T-réduit
 T-reduziert

Article number	Bag / Box	Type
10PG-262026	5 pc. / 30 pc.	26x20x26

Type: 11PG



T-branch and line reduced
 T-2X verlopend
 Pièce en T 2X réduit
 T-2X reduziert

Article number	Bag / Box	Type
11PG-201616	10 pc. / 50 pc.	20x16x16



Type: 13PG



T-female centre
T-binnendraad
Pièce en T femelle
T-IG

Article number	Bag / Box	Type
13PG-200420	10 pc. / 50 pc.	20x1/2"x20
13PG-200520	10 pc. / 30 pc.	20x3/4"x20
13PG-260426	5 pc. / 30 pc.	26x1/2"x26
13PG-260526	5 pc. / 30 pc.	26x3/4"x26
13PG-320632 *	5 pc. / 20 pc.	32x1"x32

**TILL EXHAUSTION OF STOCK*

Type: 15PG



Straight coupling
Doorverbinder recht / perssok
Manchon
Kupplung

Article number	Bag / Box	Type
15PG-1616	10 pc. / 200 pc.	16x16
15PG-2020	10 pc. / 140 pc.	20x20
15PG-2626	5 pc. / 80 pc.	26x26
15PG-3232 *	5 pc. / 50 pc.	32x32

**TILL EXHAUSTION OF STOCK*

Type: 16PG



Reducing coupling
Verloopstuk
Réduction
Kupplung-reduziert

Article number	Bag / Box	Type
16PG-2016	10 pc. / 150 pc.	20x16
16PG-2620	5 pc. / 80 pc.	26x20
16PG-3226 *	5 pc. / 40 pc.	32x26

**TILL EXHAUSTION OF STOCK*

Type: 17PG



Straight male adapter
Recht aansluitstuk buitendraad / Puntstuk
Raccord droit mâle
Übergangsfitting AG

Article number	Bag / Box	Type
17PG-1604	10 pc. / 150 pc.	16x1/2"
17PG-2004	10 pc. / 150 pc.	20x1/2"
17PG-2005	10 pc. / 150 pc.	20x3/4"
17PG-2605	5 pc. / 80 pc.	26x3/4"
17PG-2606	5 pc. / 80 pc.	26x1"
17PG-3206 *	5 pc. / 50 pc.	32x1"

**TILL EXHAUSTION OF STOCK*

Type: 18PG



Straight female adapter
Recht aansluitstuk binnendraad / Schroefbus
Raccord droit femelle
Übergangsfitting IG

Article number	Bag / Box	Type
18PG-1604	10 pc. / 150 pc.	16x1/2"
18PG-2004	10 pc. / 100 pc.	20x1/2"
18PG-2005	10 pc. / 100 pc.	20x3/4"
18PG-2605	5 pc. / 80 pc.	26x3/4"
18PG-2606	5 pc. / 50 pc.	26x1"
18PG-3206 *	5 pc. / 50 pc.	32x1"

**TILL EXHAUSTION OF STOCK*

Type: 30PG



Press-fit adapter to copper compression
Overgangsstuk Henco pers x koperbuis knelkoppeling
Manchon henco à sertir x tube de cuivre manchon à visser
Pressfitting x Klemmverbinder für Kupferrohr

Article number	Bag / Box	Type
30PG-1615S	10 pc. / 120 pc.	16x15 Cu
30PG-2022S	10 pc. / 100 pc.	20x22 Cu
30PG-2622S	10 pc. / 80 pc.	26x22 Cu

Type: 36PG



Press-fit adapter to copper press (V, M & SA-profile)
Overgangsstuk Henco pers naar koper pers (V, M & SA-profiel)
Manchon à sertir vers cuivre à sertir (profil M, V & SA)
Pressfitting Henco zu Pressfitting für Kupferrohr (Presskontur M, V & SA)

Article number	Bag / Box	Type
36PG-1615P	10 pc. / 150 pc.	16x15Cu
36PG-2015P	10 pc. / 120 pc.	20x15Cu
36PG-2022P	10 pc. / 80 pc.	20x22Cu
36PG-2615P	10 pc. / 80 pc.	26x15Cu
36PG-2622P	10 pc. / 70 pc.	26x22Cu





Type: 1



Straight male adapter
Recht aansluitstuk buitendraad / Puntstuk
Raccord droit mâle
Kupplung AG

Article number	Bag / Box	Type
1-1403C *	10 pc. / 250 pc.	14x3/8" + o-ring
1-1404	10 pc. / 250 pc.	14x1/2" + o-ring
1-1604	10 pc. / 180 pc.	16x1/2" + o-ring
1-1604Z	10 pc. / 250 pc.	16x1/2"
1-1605	10 pc. / 150 pc.	16x3/4"
1-1804	10 pc. / 150 pc.	18x1/2" + o-ring
1-1805 **	10 pc. / 150 pc.	18x3/4"
1-2004	10 pc. / 150 pc.	20x1/2" + o-ring
1-2004Z	10 pc. / 150 pc.	20x1/2"
1-2005	10 pc. / 150 pc.	20x3/4"
1-2605	5 pc. / 80 pc.	26x3/4"
1-2606	5 pc. / 80 pc.	26x1"
1-3206	5 pc. / 80 pc.	32x1"

* FOR FUEL OIL

** TILL EXHAUSTION OF STOCK

Type: 2



Straight coupling
Doorverbinder recht
Manchon
Kupplung doppelt

Article number	Bag / Box	Type
2-1616	10 pc. / 200 pc.	16x16
2-1818	10 pc. / 120 pc.	18x18
2-2020	10 pc. / 120 pc.	20x20
2-2626 *	5 pc. / 60 pc.	26x26
2-3232 *	5 pc. / 40 pc.	32x32

* TILL EXHAUSTION OF STOCK

Type: 3



Straight female adapter
Recht aansluitstuk binnendraad / Schroefbus
Raccord droit femelle
Kupplung IG

Article number	Bag / Box	Type
3-1403C * **	10 pc. / 200 pc.	14x3/8"
3-1404 **	10 pc. / 200 pc.	14x1/2"
3-1604	10 pc. / 170 pc.	16x1/2"
3-1804	10 pc. / 120 pc.	18x1/2"
3-2004	10 pc. / 120 pc.	20x1/2"
3-2005	10 pc. / 120 pc.	20x3/4"
3-2605	5 pc. / 80 pc.	26x3/4"
3-2606	5 pc. / 80 pc.	26x1"
3-3206 **	5 pc. / 80 pc.	32x1"

* FOR FUEL OIL

** TILL EXHAUSTION OF STOCK



Type: 4



Elbow 90°
Knie 90°
Coude 90°
Winkel 90°

Article number	Bag / Box	Type
4-1414 *	10 pc. / 150 pc.	14x14
4-1616	10 pc. / 110 pc.	16x16
4-2020	10 pc. / 60 pc.	20x20
4-2626	10 pc. / 40 pc.	26x26
4-3232 *	5 pc. / 32 pc.	32x32

* TILL EXHAUSTION OF STOCK

Type: 5



Elbow 90° male adapter
Knie 90° buitendraad
Coude 90° mâle
Winkel 90° AG

Article number	Bag / Box	Type
5-1604	10 pc. / 150 pc.	16x1/2"
5-1804 *	10 pc. / 100 pc.	18x1/2"
5-2005	10 pc. / 100 pc.	20x3/4"
5-2605 *	5 pc. / 40 pc.	26x3/4"
5-2606	5 pc. / 40 pc.	26x1"
5-3206 *	5 pc. / 40 pc.	32x1"

* TILL EXHAUSTION OF STOCK

Type: 6



Elbow 90° female adapter
Knie 90° binnendraad
Coude 90° femelle
Winkel 90° IG

Article number	Bag / Box	Type
6-1404 *	10 pc. / 150 pc.	14x1/2"
6-1604	10 pc. / 150 pc.	16x1/2"
6-1804 *	10 pc. / 90 pc.	18x1/2"
6-2004 *	10 pc. / 80 pc.	20x1/2"
6-2005	10 pc. / 80 pc.	20x3/4"
6-2605 *	5 pc. / 50 pc.	26x3/4"
6-2606 *	5 pc. / 30 pc.	26x1"
6-3206 *	5 pc. / 40 pc.	32x1"

* TILL EXHAUSTION OF STOCK



Type: 7



Backplate elbow with branch connection

Sanitair muurplaat binnendraad

Culasse pour sanitaire femelle

Sanitär Wandscheibe

Article number	Bag / Box	Type
7-1404 *	10 pc. / 80 pc.	14x1/2"
7-1604	10 pc. / 80 pc.	16x1/2"
7-1804 *	10 pc. / 60 pc.	18x1/2"
7-2004	10 pc. / 60 pc.	20x1/2"

** TILL EXHAUSTION OF STOCK*

Type: 7D



Double backplate elbow with branch connection

Sanitair muurplaat binnendraad dubbel

Culasse pour sanitaire femelle double

Sanitär Wandscheibe doppelt

Article number	Bag / Box	Type
7-160416	10 pc. / 50 pc.	16x1/2"x16

TILL EXHAUSTION OF STOCK

Type: 8



T-piece

T-stuk

Piece en T

T-Stück

Article number	Bag / Box	Type
8-161616	10 pc. / 70 pc.	16x16x16
8-181818 *	10 pc. / 50 pc.	18x18x18
8-202020	10 pc. / 50 pc.	20x20x20

** TILL EXHAUSTION OF STOCK*



Type: 9



T-female branch
T-binnendraad
Pièce en T femelle
T-IG

Article number	Bag / Box	Type
9-140414 *	10 pc. / 80 pc.	14x1/2"x14
9-160416	10 pc. / 80 pc.	16x1/2"x16
9-200420 *	10 pc. / 40 pc.	20x1/2"x20
9-200520	10 pc. / 40 pc.	20x3/4"x20
9-260526 *	5 pc. / 30 pc.	26x3/4"x26

* TILL EXHAUSTION OF STOCK

Type: 10



Nut, insert and jointing ring
Moer, Insert en klemring
Ecrou, insert et bîcône
Mutter, Stutzhülse und Klemmring

Article number	Bag / Box	Type
10-1604SN	10 pc. / 300 pc.	16x1/2"

TILL EXHAUSTION OF STOCK

Type: 11



T-male branch
T-buitendraad
Pièce en T mâle
T-AG

Article number	Bag / Box	Type
11-200420 *	10 pc. / 70 pc.	20x1/2"x20
11-260526 *	5 pc. / 30 pc.	26x3/4"x26
11-260626 *	5 pc. / 30 pc.	26x1"x26

* TILL EXHAUSTION OF STOCK

Type: 13



Nut, insert and jointing ring to copper compression
Adapter Henco buis naar messing knelverbinding
Raccord à visser cuivre vers multicouche
Verbindungsstück Kupfer Schraubfitting auf Henco

Article number	Bag / Box	Type
13-1415 *	10 pc. / 200 pc.	14x15 Cu
13-1615A *	10 pc. / 200 pc.	16x15 Cu
13-1615HA	10 pc. / 200 pc.	16x15 Cu
13-2022HA	10 pc. / 120 pc.	20x22 Cu
13-2628H	10 pc. / 80 pc.	26x28 Cu

* Nickel plated nut



Type: 13-VH



Adapter for Henco compression 26mm to copper compression 22mm
 Adapter Henco buis 26mm naar messing knelverbinding 22mm
 Adapteur raccord à visser cuivre 22mm vers multicouche 26mm
 Verbindungsstück für Henco Schraubfitting 26mm auf Kupfer Schraubfitting 22mm

Article number	Bag / Box	Type
13-V2622H-2	2 pc. / 70 pc.	26x22 Cu

Type: 24



Compression coupling Henco x copper tube
 Overgangsstuk Henco knel x koperbuis knelverbinding
 Raccord droit Henco x tube de cuivre manchon à visser
 Gerade Fitting Henco x Klemmverbinder für Kupferrohr

Article number	Bag / Box	Type
24-1615	10 pc. / 200 pc.	16x15 Cu
24-2022	10 pc. / 100 pc.	20x22 Cu
24-2622	5 pc. / 50 pc.	26x22 Cu
24-2628	5 pc. / 50 pc.	26x28 Cu

Type: 28



T-reduced centre
 T-verlopend
 Pièce en T réduit
 T-reduziert

Article number	Bag / Box	Type
28-201620	5 pc. / 50 pc.	20x16x20
28-202016 *	5 pc. / 50 pc.	20x20x16
28-262026 *	5 pc. / 30 pc.	26x20x26

**TILL EXHAUSTION OF STOCK*



Type: EK



Nickel plated eurocone (3/4"F)
 Euroconus schroefkoppeling (3/4"F)
 Raccord à visser eurocone (3/4"F)
 Schraubfitting Eurokonus (3/4"F)

Article number	Bag / Box	Type
EK12-2	2 pc. / 100 pc.	Ø12
EK14-2	2 pc. / 100 pc.	Ø14
EK16-2	2 pc. / 100 pc.	Ø16
EK17-2	2 pc. / 100 pc.	Ø17
EK18-2	2 pc. / 100 pc.	Ø18
EK20-2	2 pc. / 100 pc.	Ø20

Type: EKH



Brass eurocone (3/4"F)
 Euroconus-schroefkoppeling (3/4"F) niet vernikkeld
 Raccord à visser eurocone (3/4"F) laiton non nickelé
 Schraubfitting Eurokonus (3/4"F) Messing nicht vernickelt

Article number	Bag / Box	Type
EKH16-2	2 pc. / 100 pc.	Ø16

Type: EK15



Eurocone (3/4"F) for copper tube 15mm
 Euroconus-schroefkoppeling (3/4"F) voor koperbuis 15mm
 Raccord à visser eurocone (3/4"F) pour tube de cuivre 15mm
 Schraubfitting Eurokonus (3/4") für Kupferrohr 15mm

Article number	Bag / Box	Type
EK15	25 pc. / 400 pc.	Ø15

Type: SPLIT-S



Split ring for compression fittings (not for EK)
 Klemring voor schroeffittingen (niet voor EK)
 Anneau de serrage pour raccords à visser (pas pour EK)
 Klemring für Schraubfitting (nicht für EK)

Article number	Bag	Type
SPLIT-S16	10 pc.	Ø16
SPLIT-S20	10 pc.	Ø20

- 1
- 2
- 3
- 4
- 5
- 6
- 7
- 8
- 9
- 10
- 11

**Type: AB**

Elbow 90° eurocone elbow (3/4"M)
 Knie 90° voor euroconus-aansluiting (3/4"M)
 Coude 90° pour raccordement eurocone (3/4"M)
 Winkel 90° für Eurokonusanschluß (3/4"M)

Article number	Bag / Box	Type
AB1420	10 pc. / 100 pc.	3/4"x3/4" for EK

Type: ABE

Elbow 90° eurocone (3/4"M) x 1/2" male adapter
 Knie 90° buitendraad 1/2 x euroconus-aansluiting (3/4"M)
 Coude 90° mâle 1/2" x raccordement eurocone (3/4"M)
 Winkel 90° AG 1/2 x Eurokonusanschluss (3/4"M)

Article number	Bag / Box	Type
ABEK04	10 pc. / 150 pc.	1/2"x3/4"

Type: AT

Eurocone equal T
 T voor euroconus-aansluiting (3/4"M)
 Pièce en T pour raccordement eurocone (3/4"M)
 T für Eurokonusanschluß (3/4"M)

Article number	Bag / Box	Type
AT1420	10 pc. / 100 pc.	3/4"x3/4"x3/4"

Type: AD

Eurocone straight coupling (3/4"M)
 Euroconus nippel (3/4"M)
 Mamelon 2x raccordement eurocone (3/4"M)
 Nippel für 2x Eurokonusanschluss

Article number	Bag / Box	Type
AD-EKEK	10 pc. / 250 pc.	3/4"x3/4" for



Type: AN



Straight eurocone connection (3/4"M) to 1/2" male adapter
 Recht overgangsstuk 1/2"M met O-ring en -aansluiting (3/4"M)
 Manchon droit mâle 1/2" avec o-ring et eurocone
 Nippel AG 1/2" mit O-ring und Eurokonusanschluss (3/4"M)

Article number	Bag / Box	Type
AN1420	10 pc. / 250 pc.	1/2"x3/4" for

Type: 3EK



Double backplate elbow female, 2x eurocone connection
 Doorstroom muurplaat binnendraad, 2x euroconus-aansluiting
 Culasse double, 2x raccordement eurocone
 Wandscheibe doppelt IG, 2x Eurokokusanschluss

Article number	Bag / Box	Type
3EK-050405	5 pc. / 40 pc.	3/4"x1/2"x3/4" (50 mm)

Type: WALL BOX



Wall box 2 pair red/blue, 1/2"FX16mm
 Wall box 2 paar rood/blauw, 1/2"FX16mm
 Wall box 2 paires rouge/bleu, 1/2"FX16mm
 Wall box 2 Paare red/blau, 1/2"FX16mm

Article number	Bag / Box	Type.
WBS-1604	1 pc. / 40 pc.	16x1/2"



Instruction video

- 1
- 2
- 3
- 4
- 5
- 6
- 7
- 8
- 9
- 10
- 11





Type: V-06



Manifold 1", 1/2" female thread, 3/8" air vent hole
Verdeler 1", 1/2" aansluitingen, 3/8" ontluchtingsopening
Collecteur 1", conn. 1/2" femelle, conn. 3/8" pour purgeur
Verteiler 1", 1/2" IG, 3/8" Loch für Entlüftung

Article number	pc / Box	Type
V-060402	1 pc. / 64 pc.	1" 2x1/2" x 3/8"
V-060403	1 pc. / 48 pc.	1" 3X1/2" x 3/8"
V-060404	1 pc. / 30 pc.	1" 4x1/2" x 3/8"
V-060405	1 pc. / 28 pc.	1" 5x1/2" x 3/8"
V-060406	1 pc. / 20 pc.	1" 6x1/2" x 3/8"
V-060407	1 pc. / 25 pc.	1" 7x1/2" x 3/8"
V-060408	1 pc. / 20 pc.	1" 8x1/2" x 3/8"
V-060409*	1 pc. / 20 pc.	1" 9x1/2" x 3/8"

** TILL EXHAUSTION OF STOCK*

Type: V-05-Z



Manifold 3/4", 1/2" female thread
Verdeler 3/4", 1/2" aansluitingen
Collecteur 3/4", conn. 1/2" femelle
Verteiler 3/4", 1/2" IG

Article number	pc / Box	Type
V-050403-Z	1 pc. / 48 pc.	3/4" 3x1/2"
V-050404-Z	1 pc. / 30 pc.	3/4" 4x1/2"
V-050405-Z	1 pc. / 42 pc.	3/4" 5x1/2"
V-050406-Z*	1 pc. / 20 pc.	3/4" 6x1/2"

** TILL EXHAUSTION OF STOCK*

Type: V-06-Z

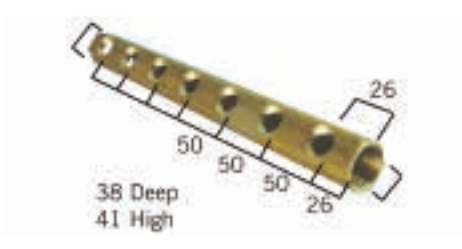

Manifold 1", 1/2" female thread
Verdeler 1", 1/2" aansluitingen
Collecteur 1", conn. 1/2" femelle
Verteiler 1", 1/2" IG

Article number	pc / Box	Type
V-060402-Z	1 pc. / 64 pc.	1" 2x1/2"
V-060408-Z	1 pc. / 20 pc.	1" 8x1/2"

Type: V-07-Z

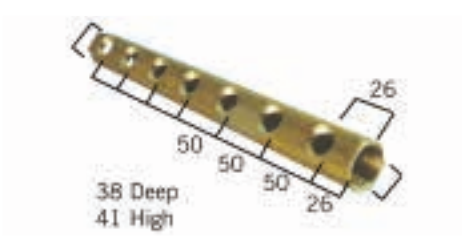

Manifold 5/4", 1/2" female thread
Verdeler 5/4", 1/2" aansluitingen
Collecteur 5/4", conn. 1/2" femelle
Verteiler 5/4", 1/2" IG

Article number	pc / Box	Type
V-070405-Z	1 pc. / 14 pc.	5/4" 5x1/2"
V-070406-Z	1 pc. / 15 pc.	5/4" 6x1/2"
V-070407-Z	1 pc. / 20 pc.	5/4" 7x1/2"
V-070408-Z	1 pc. / 20 pc.	5/4" 8x1/2"
V-070410-Z	1 pc. / 10 pc.	5/4" 10x1/2"

- 1
- 2
- 3
- 4
- 5
- 6
- 7
- 8
- 9
- 10
- 11



Type: VEK-06



Manifold 1" with connections and one 3/8" air vent hole
Verdeler 1" met EK-aansluitingen en 3/8" ontluichtingsopening
Collecteur 1" avec des raccords eurocone et un trou 3/8" pour purgeur
Verteiler 1" mit -Anschlüssen und 3/8" Loch für Entlüftung

Article number	pc / Box	Type
VEK-060502	1 pc. / 48 pc.	1" 2x3/4" x 3/8"
VEK-060503	1 pc. / 32 pc.	1" 3x3/4" x 3/8"
VEK-060504	1 pc. / 20 pc.	1" 4x3/4" x 3/8"
VEK-060505	1 pc. / 21 pc.	1" 5x3/4" x 3/8"
VEK-060506	1 pc. / 20 pc.	1" 6x3/4" x 3/8"
VEK-060507	1 pc. / 20 pc.	1" 7x3/4" x 3/8"
VEK-060508	1 pc. / 20 pc.	1" 8x3/4" x 3/8"
VEK-060509	1 pc. / 15 pc.	1" 9x3/4" x 3/8"
VEK-060510	1 pc. / 15 pc.	1" 10x3/4" x 3/8"

Type: VEK-06-Z

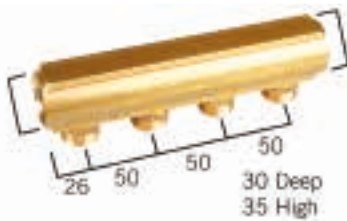

Manifolds 1" with eurocone connections
Verdeler 1" met euroconus-aansluitingen
Collecteur 1" avec des raccords eurocone
Verteiler 1" mit Eurokonus-Anschlüssen

Article number	pc / Box	Type
VEK-060502-Z	1 pc. / 48 pc.	1" 2x3/4"
VEK-060503-Z	1 pc. / 32 pc.	1" 3x3/4"
VEK-060504-Z	1 pc. / 20 pc.	1" 4x3/4"
VEK-060505-Z	1 pc. / 21 pc.	1" 5x3/4"
VEK-060506-Z	1 pc. / 20 pc.	1" 6x3/4"
VEK-060507-Z	1 pc. / 20 pc.	1" 7x3/4"
VEK-060508-Z	1 pc. / 20 pc.	1" 8x3/4"
VEK-060509-Z	1 pc. / 15 pc.	1" 9x3/4"
VEK-060510-Z	1 pc. / 15 pc.	1" 10x3/4"

Type: VEK-05-Z

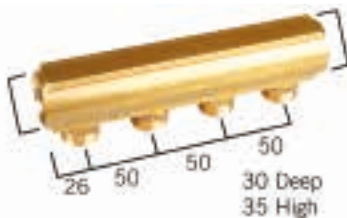

Manifold 3/4" with eurocone connections
Verdeler 3/4" met euroconus-aansluitingen
Collecteur 3/4" avec des raccords eurocone
Verteiler 3/4" mit Eurokonus-Anschlüssen

Article number	pc / Box	Type
VEK-050502-Z	8 pc. / 64 pc.	3/4" 2x3/4"
VEK-050504-Z	6 pc. / 30 pc.	3/4" 4x3/4"
VEK-050505-Z	4 pc. / 28 pc.	3/4" 5x3/4"
VEK-050507-Z	1 pc. / 25 pc.	3/4" 7x3/4"
VEK-050508-Z	1 pc. / 25 pc.	3/4" 8x3/4"
VEK-050509-Z	1 pc. / 20 pc.	3/4" 9x3/4"

TILL EXHAUSTION OF STOCK



Type: VEK-05-ZV



Manifold 3/4" with eurocone connections
Verdeler 3/4" met euroconus-aansluitingen
Collecteur 3/4" avec des raccordements eurocone
Verteiler 3/4" mit Eurokonus-Anschlüssen

Article number	pc / Box	Type
VEK-050502-ZV	1 pc. / 8 pc.	3/4" 2x3/4"

TILL EXHAUSTION OF STOCK

Type: VEK-06-ZV



Manifold 1" with eurocone connections
Verdeler 1" met euroconus-aansluitingen
Collecteur 1" avec des raccordements eurocone
Verteiler 1" mit Eurokonus-Anschlüssen

Article number	pc / Box	Type
VEK-060502-ZV	1 pc. / 8 pc.	1" 2x3/4"

TILL EXHAUSTION OF STOCK

Type: H-0212



Insulated manifold bracket (pairs)
Ophangbeugel dubbel met isolatie voor alle verdelers
Support double avec isolation pour tous les collecteurs
Verteiler-Halter mit Isolierung doppelt für alle Verteiler

Article number	pc / Box	Type
H-0212	1 pc. / 150 pc.	3/4" - 1 - 5/4"

Type: H-0212-S



Insulated manifold bracket (single)
Ophangbeugel enkel met isolatie voor alle verdelers
Support simple avec isolation pour tous les collecteurs
Verteiler-Halter mit Isolierung einfach für alle Verteiler

Article number	pc / Box	Type
H-0212-S	1 pc. / 500 pc.	3/4" - 1" - 5/4"

- 1
- 2
- 3
- 4
- 5
- 6
- 7
- 8
- 9
- 10
- 11



- 1
- 2
- 3
- 4
- 5
- 6
- 7
- 8
- 9
- 10
- 11

Type: VS REDUCTIE



Manifold reducer with O-ring
Reductie met O-ring voor verdeler
Réduction avec O-ring pour collecteur
Reduktion für Verteiler mit O-ring

Article number	pc / Box	Type
VS-0504	10 pc. / 500 pc.	3/4"x1/2"
VS-0604	10 pc. / 250 pc.	1"x1/2"
VS-0605	10 pc. / 250 pc.	1"x3/4"

Type: VS BLINDSTOP



Manifold plug with O-ring
Blindstop met O-ring voor verdeler
Bouchon avec O-ring pour collecteur
Stopfen mit O-Ring für Verteiler

Article number	pc / Box	Type
VS-05	10 pc. / 250 pc.	3/4"
VS-06	10 pc. / 200 pc.	1"
VS-07	10 pc. / 200 pc.	5/4"

Type: VB-EK05



Ball valve, 2 x eurocone connection
Bolkraan , 2 x euroconus aansluiting
Vanne d'arrêt, 2 x raccordement eurocone
Kugelhahn, 2 x Eurokonus

Article number	Box / Big Box	Type
VB-EK05	25 pc. / 200 pc.	3/4" EK x 3/4" EK

Type: VR-EK05



Lockshield 2x eurocone connection
Regelkraan 2x euroconus aansluiting
Te de reglage 2x raccordement eurocone
Asperrbare Ventil 2x eurokonus

Article number	Type
VR-EK05	3/4" EK x 3/4" EK

Type: VB05



Manifold 3/4" with ball valves and eurocone connection

Verdeler 3/4" met bolkraan en euroconus-aansluiting

Collecteur 3/4" avec vanne d'arrêt et eurocone

Verteiler 3/4" mit Kugelhahnset und Eurokonus

Article number	pc / Box	Type
VB050502-BLAUW	5 pc. / 50 pc.	3/4"x2xEK14,16,18 & 20
VB050502-ROOD	5 pc. / 50 pc.	3/4"x2xEK14,16,18 & 20
VB050503-BLAUW	5 pc. / 50 pc.	3/4"x3xEK14,16,18 & 20
VB050503-ROOD	5 pc. / 50 pc.	3/4"x3xEK14,16,18 & 20
VB050504-BLAUW	4 pc. / 40 pc.	3/4"x4xEK14,16,18 & 20
VB050504-ROOD	4 pc. / 40 pc.	3/4"x4xEK14,16,18 & 20

Type: VB06



Manifold 1" with ball valves and eurocone connection

Verdeler 1" met bolkraan en euroconus-aansluiting

Collecteur 1" avec vanne d'arrêt et eurocone

Verteiler 1" mit Kugelhahnset und Eurokonus

Article number	pc / Box	Type
VB060502-BLAUW	5 pc. / 50 pc.	1"x2xEK14,16,18 & 20
VB060502-ROOD	5 pc. / 50 pc.	1"x2xEK14,16,18 & 20
VB060503-BLAUW	5 pc. / 40 pc.	1"x3xEK14,16,18 & 20
VB060503-ROOD	5 pc. / 40 pc.	1"x3xEK14,16,18 & 20
VB060504-BLAUW	4 pc. / 40 pc.	1"x4xEK14,16,18 & 20
VB060504-ROOD	4 pc. / 40 pc.	1"x4xEK14,16,18 & 20

Type: VBS05



Manifold 3/4" with ball valves and eurocone connection

Verdeler 3/4" met bolkraan en euroconus-aansluiting

Collecteur 3/4" avec vanne d'arrêt et eurocone

Verteiler 3/4" mit Kugelhahnset und Eurokonus

Article number	pc / Box	Type
■ VBS050502-BL	1 pc. / 20 pc.	3/4"x2xEK14,16,18 & 20
■ VBS050502-RO	1 pc. / 20 pc.	3/4"x2xEK14,16,18 & 20
■ VBS050503-BL	1 pc. / 15 pc.	3/4"x3xEK14,16,18 & 20
■ VBS050503-RO	1 pc. / 15 pc.	3/4"x3xEK14,16,18 & 20
■ VBS050504-BL	1 pc. / 10 pc.	3/4"x4xEK14,16,18 & 20
■ VBS050504-RO	1 pc. / 10 pc.	3/4"x4xEK14,16,18 & 20

Type: VBS06



Manifold 1" with ball valves and eurocone connection

Verdeler 1" met bolkraan en euroconus-aansluiting

Collecteur 1" avec vanne d'arrêt et eurocone

Verteiler 1" mit Kugelhahnset und Eurokonus

Article number	pc / Box	Type
■ VBS060502-BL	1 pc. / 20 pc.	1"x2xEK14,16,18 & 20
■ VBS060502-RO	1 pc. / 20 pc.	1"x2xEK14,16,18 & 20
■ VBS060503-BL	1 pc. / 15 pc.	1"x3xEK14,16,18 & 20
■ VBS060503-RO	1 pc. / 15 pc.	1"x3xEK14,16,18 & 20
■ VBS060504-BL	1 pc. / 10 pc.	1"x4xEK14,16,18 & 20
■ VBS060504-RO	1 pc. / 10 pc.	1"x4xEK14,16,18 & 20



Type: RAD04-100V



Radiator connector with 3/4" eurocone connections, straight
Onderblok met 3/4" euroconus-aansluitingen, recht
Raccord radiateur, droit, eurocone
Heizkörperanschluss 1/2" mit 3/4" Eurokonus-Anschlüssen, unten

Article number	Box / Big Box	Type
RAD04-100V	10 pc. / 100 pc.	1/2"x3/4" EK

Type: RAD04-100H



Radiator connector with 3/4" eurocone connections, Elbow
Onderblok met 3/4" euroconus-aansluitingen, haaks
Raccord radiateur, équerre, eurocone
Heizkörperanschluss 1/2" mit 3/4" Eurokonus-Anschlüssen, hinten

Article number	Box / Big Box	Type
RAD04-100H	10 pc. / 100 pc.	1/2"x3/4" EK

TILL EXHAUSTION OF STOCK

Type: EK15



Eurocone (3/4"F) for copper tube 15mm
Euroconus-schroefkoppeling (3/4"F) voor koperbuis 15mm
Raccord à visser eurocone (3/4"F) pour tube en cuivre 15mm
Schraubfitting Eurokonus (3/4") für Kupferrohr 15mm

Article number	Box / Big Box	Type
EK15	25 pc. / 400 pc.	Ø15

Type: RADK2-R



Radiator valve 1/2" with 3/4" eurocone connection, straight
Radiatorkraan 1/2" met 3/4" euroconus-aansluiting, recht
Vanne radiateur droite 1/2" avec raccordement
Heizkörperventil 1/2" mit 3/4" Eurokonus-Anschluss, gerade

Article number	Box / Big Box	Type
RADK2-R	10 pc. / 100 pc.	1/2"x3/4" EK

TILL EXHAUSTION OF STOCK

- 1
- 2
- 3
- 4
- 5
- 6
- 7
- 8
- 9
- 10
- 11

Type: RADTH-VL



Thermostatic radiator valve head
 Thermostatisch regelement met vaste vloeistofvoeler
 Tête thermostatique à bulbe, équipée d'un réglage de température limite
 Thermostatkopf mit festem Flüssigkeitsfühler

Article number	Box / Big Box	Type
RADTH-VL	10 pc. / 150 pc.	THERM

TILL EXHAUSTION OF STOCK

Type: RADV-2-R



2-way lockshield valve 1/2", straight x 3/4" eurocone
 Voetventiel 1/2" 2-weg recht x 3/4" euroconus
 Raccord droit réglable, 1/2" x eurocone
 Absperrbare Rücklaufverschraubung Durchgang x 3/4" Eurokonus

Article number	Box / Big Box	Type
RADV-2-R	10 pc. / 100 pc.	1/2"x3/4"

TILL EXHAUSTION OF STOCK

Type: RADH4-100V



Straight radiator H-block with valve, supplied without nipple x 3/4" eurocone
 Radiator H-blok met afsluiter, recht, geleverd zonder nippel x 3/4" euroconus
 Raccord robinet vertical, eurocone, livré sans nipples
 Heizkörperanschlussgarnitur mit 3/4" Eurokonus-Anschlüssen, unten

Article number	Box	Type
RADH4-100V	50 pc.	3/4"x3/4" EK

Type: RADH4-100H



Elbow radiator H-block with valve, supplied without nipple x 3/4" eurocone
 Radiator H-blok met afsluiter, haaks, geleverd zonder nippel x 3/4" euroconus
 Raccord robinet horizontal, eurocone, livré sans nipples
 Heizkörperanschlussgarnitur mit 3/4" Eurokonus-Anschlüssen, hinten

Article number	Box	Type
RADH4-100H	50 pc.	3/4"x3/4" EK

Type: RADNI

Nipple for H radiator block
 Nippel voor H-radiatorblok
 Vanne pour raccord radiateur (H&V)
 Nippel für H-Anschluss

Article number	Bag / Box	Type
RADNI-0504	10 pc. / 500 pc.	1/2"x3/4"

Type: RAD-H

Micromatic wheelhandle for thermostatic valve
 Micromatisch handvat voor thermostatische kraan
 Capuchon micromatique pour vanne thermostatique
 Handgriff für Thermostatventil

Article number	Box	Type
RAD-H	50 pc.	HANDLE

TILL EXHAUSTION OF STOCK

Type: RAD-B

Elbow 1/2"
 Koppeling 1/2"
 Coude 1/2"
 Winkel 1/2"

Article number	Box / Big Box	Type
RAD-B	25 pc. / 275 pc.	1/2"x3/4"

TILL EXHAUSTION OF STOCK

Type: BAP-H

Ball valve with handle, 2 x pressfitting
 Kogelkraan met handvat, 2 x perskoppeling
 Vanne à bille
 Kugelhahnset mit Handgriff, 2 x Pressfitting

Article number	Box / Big Box	Type
BAP-H1616	10 pc. / 100 pc.	16x16
BAP-H1818	10 pc. / 100 pc.	18x18
BAP-H2020	10 pc. / 100 pc.	20x20
BAP-H2626	10 pc. / 100 pc.	26x26
BAP-H3232	10 pc. / 100 pc.	32x32

- 1
- 2
- 3
- 4
- 5
- 6
- 7
- 8
- 9
- 10
- 11

Type: BAP-SK



Ball valve with handle, 2 x pushfitting
 Kogelkraan met handvat, 2 x steekfitting
 Vanne à bille
 Kugelhahnset mit Handgriff, 2 x Pushfitting

Article number	Box / Big Box	Type
BAP-SK1616	6 pc. / 60 pc.	16x16
BAP-SK2020	6 pc. / 30 pc.	20x20
BAP-SK2626	6 pc. / 30 pc.	26x26

Type: BAP-SV



Stopvalve DN10
 Stopbolkraan DN10
 Vanne d'arrêt DN10
 Stopvalve DN10

Article number	Box / Big Box	Type
BAP-SV1610S	10 pc. / 100 pc.	16 x 10

Type: BAP-CC



Built in ball valve with crhomed cap 2 x pressfitting
 Inbouwbolkraan met verchromde dop, 2 x perskoppeling
 Vanne à sphere avec bouchon chromé, 2x à sertir
 Einbau Kugelhahnset mit Kappe verchromt, 2 x Pressfitting

Article number	Box / Big Box	Type
BAP-CC2626	5 pc. / 50 pc.	20x20

TILL EXHAUSUTION OF STOCK

Type: BAP-CH



Built in ball valve with crhomed lever handle 2 x pressfitting
 Inbouwbolkraan met verchromde hefboomhandvat, 2 x perskoppeling
 Vanne à sphere avec mache levier chromé, 2x à sertir
 Einbau Kugelhahnset mit Hebelhandgriff verchromt, 2 x Pressfitting

Article number	Box / Big Box	Type
BAP-CH1616	5 pc. / 60 pc.	16x16
BAP-CH2626	5 pc. / 50 pc.	26x26

Type: BA-F



Built in ball valve Fastec DN15

Inbouwbolkraan Fastec DN15

Vanne à sphere Fastec DN15

Einbau Kugelhahnset Fastec DN15

Article number	Box / Big Box	Type
BA-F41	1 pc. / 50 pc.	

BA-F41

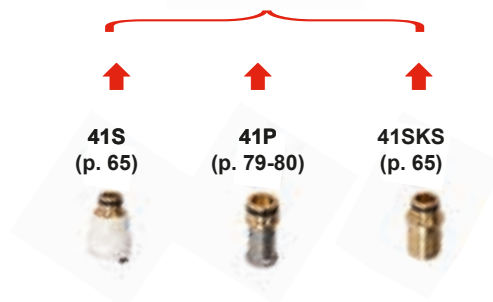

- 1
- 2
- 3
- 4
- 5
- 6
- 7
- 8
- 9
- 10
- 11



	<i>Page</i>
A. SYSTEMS	107
B. MANIFOLDS	119
C. CONTROL UNITS	130
D. GEOTHERMAL	140



Type: UFH-ISOPRO30



System plate with 30 mm EPS insulation and 28dB acoustic improvement
 Noppenplaat met 30 mm EPS isolatie, 28 dB geluidsverbetering
 Plaque à plot avec isolation EPS de 30 mm, isolant acoustique 28dB
 Systemplatte mit Dämmung Styropor 30 mm, Trittschalldverbesserung 28dB

Article number	Packing	Type
UFH-ISOPRO30 *	6,72m ² (6 x 1,12m ²)	1400x800mm - 5kPa - 28dB

* Pipe Ø16, centre-to-centre: multiple 50mm hor./ver.

Type: UFH-ISOPRO11



System plate with 11 mm EPS insulation
 Noppenplaat met 11 mm EPS isolatie
 Plaque à plot avec isolation EPS de 11 mm
 Systemplatte mit Dämmung Styropor 11 mm

Article number	Packing	Type
UFH-ISOPRO11 *	14,56m ² (13 x 1,12m ²)	1400x800mm - 75kPa

* Pipe Ø16, centre-to-centre: multiple 50mm hor./ver.

Type: UFH-PRO



System plate without insulation
 Noppenplaat zonder isolatie
 Plaque à plot sans isolation
 Systemplatte ohne Dämmung

Article number	Packing	Type
UFH-PRO *	13,44m ² (12 x 1,12m ²)	1400x800mm - 5kPa

* Pipe Ø16, centre-to-centre: multiple 50mm hor./ver.

Type: UFH-ISO



EPS insulation board
 Vlakke EPS isolatieplaat
 Isolation EPS lisse
 Dämmung aus Styropor

Article number	Packing	Type
UFH-ISO-20	15 m ²	1000 x 500 x 20 mm

TILL EXHAUSTION OF STOCK

Type: UFH-PRO-DIA



Diagonal holder for system plate
 Diagonaalhouder voor noppenplaat
 Fixation diagonale en film PS
 Diagonalbefestigung aus PS

Article number	Packing	Type
UFH-PRO-DIA *	40 pc.	50 mm

* Centre-to-centre distance diagonal: multiple 70mm

Type: UFH-ISOPRO-AD30



Insulation plate for transition piece, 30 mm
 Isolatieplaat voor overgangsstuk, 30 mm
 Pièce de jonction en isolation EPS de 30 mm
 Anschlussstück aus Styropordämmung 30 mm

Article number	Packing	Type
UFH-ISOPRO-AD30	1 pc.	1000x200x30mm

TILL EXHAUSTION OF STOCK

Type: UFH-ISOPRO-AD11



Insulation plate for transition piece, 11 mm
 Isolatieplaat voor overgangsstuk, 11 mm
 Pièce de jonction en isolation EPS de 11 mm
 Anschlussstück aus Styropordämmung 11 mm

Article number	Packing	Type
UFH-ISOPRO-AD11	1 pc.	1000x200x11mm

TILL EXHAUSTION OF STOCK

Type: UFH-PRO-ADA



Transition piece without insulation for system plate
 Overgangsstuk zonder isolatie voor noppenplaat
 Pièce de jonction en film PS sans isolation
 Anschlussstück aus PS ohne Dämmung

Article number	Packing	Type
UFH-PRO-ADA	1 pc.	1450x210mm



Type: UFH-PRO-IND



System plate without insulation, industrial application
 Noppenplaat zonder isolatie, voor industriële toepassing
 Plaque à plot sans isolation, application industrielle
 Systemplatte ohne Dämmung, Industrieanwendungen

Article number	Packing	Type
UFH-PRO-IND *	19,44m ² (18 x 1,08m ²)	1275x975mm

* Pipe Ø16-20, centre-to-centre distance: multiple 75mm hor./ver.

Type: UFH-RAS10

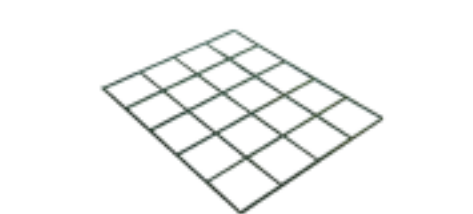

Galvanized steel mesh, 100 x 100 mm, 3 mm
 Stalen draadmat verzinkt, 100 x 100 mm, 3 mm
 Treillis en acier galvanisé, trame de 100 x 100 mm, 3 mm
 Trägermatte aus Eisen verzinkt, Masche 100 x 100 mm, 3 mm

Article number	Packing	Type
UFH-RAS10	10 pc.	2,52m ² - grid 100x100mm

Type: UFH-RAS15

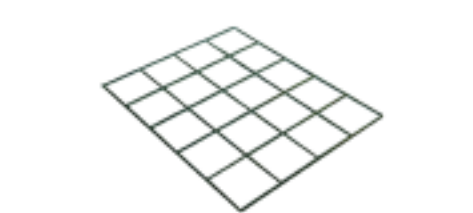

Galvanized steel mesh, 150 x 150 mm, 3 mm
 Stalen draadmat verzinkt, 150 x 150 mm, 3 mm
 Treillis en acier galvanisé, trame de 150 x 150 mm, 3 mm
 Trägermatte aus Eisen verzinkt, Masche 150 x 150 mm, 3 mm

Article number	Packing	Type
UFH-RAS15	10 pc.	2,52m ² - grid 150x150mm

Type: UFH-RAS20

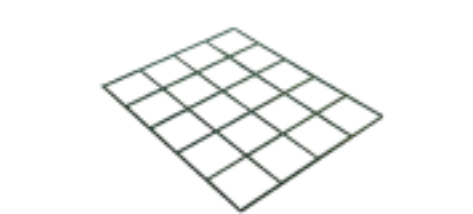

Galvanized steel mesh, 200 x 200 mm, 3 mm
 Stalen draadmat verzinkt, 200 x 200 mm, 3 mm
 Treillis en acier galvanisé, trame de 200 x 200 mm, 3 mm
 Trägermatte aus Eisen verzinkt, Masche 200 x 200 mm, 3 mm

Article number	Packing	Type
UFH-RAS20	10 pc.	2,88m ² - grid 200x200mm

Type: UFH-RAS25

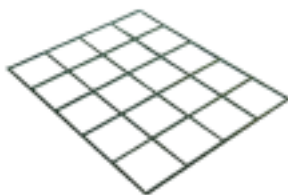

Galvanized steel mesh, 250 x 250 mm, 3 mm
 Stalen draadmat verzinkt, 250 x 250 mm, 3 mm
 Treillis en acier galvanisé, trame de 250 x 250 mm, 3 mm
 Trägermatte aus Eisen verzinkt, Masche 250 x 250 mm, 3 mm

Article number	Packing	Type
UFH-RAS25	10 pc.	2,77m ² - grid 250x250mm

Type: UFH-RAS-RB3

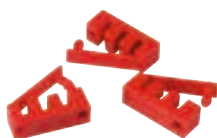

Connection clip for steel mesh
 Verbindingsclip voor stalen draadmatten
 Clip de fixation pour treillis
 Verbinder für Trägermatte

Article number	Packing	Type
UFH-RAS-RB3	30 pc.	RB

Type: UFH-RAS-BIND15



Steel strand, plasticized, to connect pipe on steel mesh
 Stalen vlechtdraad, geplastificeerd, om buis op draadmat te binden
 Fil de tressage métallique, plastifié, pour fixer tube sur treillis
 Stahldraht, plastifiziert, für Befestigung der Rohre auf Trägermatte

Article number	Packing	Type
UFH-RAS-BIND15A	250 pc.	160 mm
UFH-RAS-BIND15B	2500 pc.	160 mm

Type: UFH-RAS-CLIP



Synthetic clip for steel mesh
 Kunststofclip voor draadmat
 Attache en plastique pour treillis
 Rohrclip für Trägermatte

Article number	Packing	Type
UFH-RAS-CLIP16	200 pc.	Ø16
UFH-RAS-CLIP18	200 pc.	Ø18
UFH-RAS-CLIP20	200 pc.	Ø20

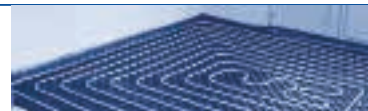

Type: UFH-TACK-KLS

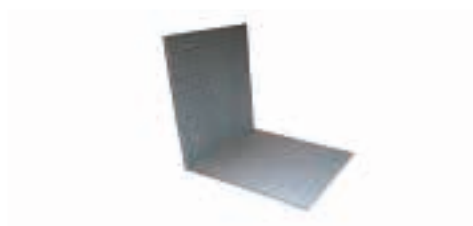

Tacker sheet with EPS insulation, foil with 100 x 100 mm grid marking and overlap, acoustic improvement

Tacker klapset met EPS isolatie voorzien van folie met raster 100 x 100 mm en overlap, geluidsverbetering

Plaque tacker en isolation EPS, film avec trame 100 x 100 mm et rabat, isolant acoustique

Verbundplatte aus Styropordämmung mit Folie Masche 100 x 100 mm und Überschneidung, Trittschallverbesserung

Article number	Packing	Type
UFH-TACK-KLS15	10 m ² (5 x 2 m ²)	1000x2000x15mm - 4kPa - 17dB
UFH-TACK-KLS20	10 m ² (5 x 2 m ²)	1000x2000x20mm - 4kPa - 33dB
UFH-TACK-KLS25	10 m ² (5 x 2 m ²)	1000x2000x25mm - 4kPa - 33dB
UFH-TACK-KLS30	10 m ² (5 x 2 m ²)	1000x2000x30mm - 4kPa - 33dB
UFH-TACK-KLS35	10 m ² (5 x 2 m ²)	1000x2000x35mm - 4kPa - 33dB

Type: UFH-TACK-ROL



Tacker roll with EPS insulation, foil with marking 100 x 100 mm and overlap, up to 29dB acoustic improvement

Tacker rol met EPS isolatie voorzien van folie met raster 100 x 100 mm en overlap, tot 29dB geluidsverbetering

Rouleau tacker en isolation EPS, film plastique avec trame 100 x 100 mm et rabat, isolant acoustique jusqu'à 29dB

Roll-Dämmung aus Styropor mit Folie 100 x 100 mm und Überschneidung, Trittschallverbesserung bis 29dB

Article number	Packing	Type
UFH-TACK-ROL20	10 m ² (1 x 10 m ²)	1000x10.000x20mm - 4kPa - 28dB
UFH-TACK-ROL25	10 m ² (1 x 10 m ²)	1000x10.000x25mm - 4kPa - 28dB
UFH-TACK-ROL30	10 m ² (1 x 10 m ²)	1000x10.000x30mm - 4kPa - 29dB
UFH-TACK-ROL35	10 m ² (1 x 10 m ²)	1000x10.000x35mm - 4kPa - 29dB

Type: UFH-TACK-38K



Tacker clip, 38 mm

Tackernagel, 38 mm

Agrafe tacker, 38 mm

Tackernadel, 38 mm

Article number	Box / Big Box	Type
UFH-TACK-38K *	300 pc. / 6000 pc.	38 mm

* Pipe Ø 16

Type: UFH-TACK-40



Tacker clip, 40 mm

Tackernagel, 40 mm

Agrafe tacker, 40 mm

Tackernadel, 40 mm

Article number	Box / Big Box	Type
UFH-TACK-40 *	300 pc. / 8.400 pc.	40 mm

* Pipe Ø 16-20

Type: UFH-TACK-60



Tacker clip, 60 mm
Tackernagel, 60 mm
Agrafe tacker, 60 mm
Tackernadel, 60 mm

Article number	Box / Big Box	Type
UFH-TACK-60 *	300 pc. / 6.000 pc.	60 mm

* Pipe Ø 16-20

Type: UFH-TACK



Tacker machine for UFH-TACK-40, UFH-TACK-60
Tackerapparaat voor UFH-TACK-40, UFH-TACK-60
Appareil Tacker pour UFH-TACK-40, UFH-TACK-60
Tackergerät für UFH-TACK-40, UFH-TACK-60

Article number	Packing	Type
UFH-TACK	1 pc.	for UFH-TACK-40 / UFH-TACK-60

Type: UFH-SCOTCH-66



Adhesive tape
Kleefband
Ruban adhésif
Klebeband

Article number	Packing	Type
UFH-SCOTCH-66	1 pc.	66 m

Type: UFH-P18-GP18



Gypsum fibreboard 18mm, round milling for RENO12 system
Gipsvezelplaat 18mm, ronde frezing voor RENO12 systeem
Plaques en fibro-plâtre 18mm, avec une fraisage circulaire système RENO12
Gipsfaserplatte 18mm, runde Fräsung für das RENO12 system

Article number	pc	Type
UFH-P18-GP18	1 pc.	1000 x 600 x 18mm

Type: UFH-P18-GP18V



Gypsum fibreboard 18mm, vertical milling for RENO12 system
Gipsvezelplaat 18mm, verticale frezing voor RENO12 systeem
Plaques en fibro-plâtre 18mm, système RENO12
Gipsfaserplatte 18mm, vertikale Fräsung für das RENO12 system

Article number	pc	Type
UFH-P18-GP18V	1 pc.	1000 x 600 x 18mm

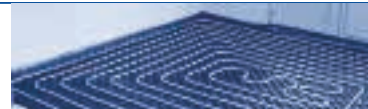

Type: UFH-P18-GP10



Gypsum fibreboard 10mm, flat for RENO12 system
 Gipsvezelplaat 10mm, vlak voor RENO12 systeem
 Plaques en fibro-plâtre 10mm, système RENO12
 Gipsfaserplatte 10mm, flach für das RENO12 system

Article number	pc	Type
UFH-P18-GP10	1 pc.	1500 x 1000 x 10mm

Type: UFH-P18-WN



Mesh for RENO12 system
 Wapeningsnet voor RENO12 systeem
 Treillis d'armature système RENO12
 Betonstahlmatte für das RENO12 system

Article number	Packing	Type
UFH-P18-WN	50 m ²	1 x 50m

Type: UFH-ISODRY-25



Insulation system board for dry system
 Isolatieplaat voor droog systeem
 Panneau d'isolation pour système sec
 Systemplatte für Trockenbau

Article number	Packing	Type
UFH-ISODRY-25	10 m ²	1000x500x25mm

Type: UFH-DRY-GP100-2



Heat diffusion profile for dry system
 Stralingsprofiel voor droog systeem
 Profil de diffusion pour système sec
 Wärmeleitlamelle für Trockenbau

Article number	Packing	Type
UFH-DRY-GP100-2	50 pc.	997x120x0,4mm - Ø16

- 1
- 2
- 3
- 4
- 5
- 6
- 7
- 8
- 9
- 10
- 11

Type: UFH-DRY-VD100



Heat diffusion board for dry system
Stralingsverdeelplaat voor droog systeem
Panneau de diffusion pour système sec
Verteillerbleche für Trockenbau

Article number	Packing	Type
UFH-DRY-VD100	1 pc.	1000x1000mm

Type: UFH-DRY-B



Synthetic mounting bracket for pipe in diagonal position
kunststofbeugel voor bevestiging buis bij diagonaalverlegging
Fixation en plastique pour pose du tube diagonal
Kunststoffreiter für Diagonalverlegung

Article number	Packing	Type
UFH-DRY-B	100	

Type: UFH-UP-M



Clip rail with adhesive strip, centres 50 mm
U-profiel met kleefband, verlegafstand 50 mm
Profil-U avec bande adhésif, distance de pose 50 mm
Kunststoffclip-Schiene klebfertig für Rohr, Verlegung 50 mm

Article number	Box / Pallet	Type
UFH-UP-14M1	100 m / 1000 m	Ø14 - AS 25 mm- 1000 mm
UFH-UP-16M1	100 m / 1000 m	Ø16 - AS 50 mm- 1000 mm

Type: UFH-UP



Clip rail with adhesive strip, centres 50 mm
U-profiel met kleefband, verlegafstand 50 mm
Profil-U avec bande adhésif, distance de pose 50 mm
Kunststoffclip-Schiene klebfertig für Rohr, Verlegung 50 mm

Article number	Box / Pallet	Type
UFH-UP-12	32 m / 960 m	Ø12 - AS 25 mm- 2000 mm
UFH-UP-14	100 m / 2500 m	Ø14 - AS 25 mm- 2500 mm
UFH-UP-16	100 m / 3000 m	Ø16 - AS 50 mm- 2500 mm
UFH-UP-20	100 m / 896 m	Ø20 - AS 50 mm- 2000 mm



Type: UFH-UP-Z



Clip rail without adhesive strip, centres 50 mm
 U-profiel zonder kleefband, verlegafstand 50 mm
 Profil-U sans bande adhésif, distance de pose 50 mm
 Kunststoffclip-Schiene nicht klebfertig , Verlegung 50 mm

Article number	Box / Pallet	Type
UFH-UP-1826M1Z	50 m / 600 m	Ø18, 20, 26 - AS 50 mm - 1000

Type: UFH-UP-CUP



Staple for clip rail
 Clip voor U-profielen
 Agrafe pour profil-U
 Nadel für Schienen

Article number	Box / Big Box	Type
UFH-UP-CUP50	500 pc. / 9000 pc.	50 mm

Type: UFH-FOIL



PE film, transparant, with blue grid marking 50 x 50 mm
 PE-folie, transparant, blauwe rastermarkering 50 x 50 mm
 Film en PE, transparent avec marquage 50 x 50 mm en bleu
 Polyethylen-Schutzfolie, transparent, Markierung Blau 50x50mm

Article number	Packing	Type
UFH-FOIL50	51 m ²	34m x 1,5m - 0,2mm
UFH-FOIL90	90 m ²	60m x 1,5m - 0,2mm

Type: UFH-FOIL-N



PE film, neutral
 PE-folie, neutraal
 Film en PE, neutre
 Polyethylen-Schutzfolie, neutral

Article number	Packing	Type
UFH-FOIL-N	100 m ²	50 m x 2 m - 0,2 mm

- 1
- 2
- 3
- 4
- 5
- 6
- 7
- 8
- 9
- 10
- 11

Type: UFH-FOIL-ALU



PE film, reflecting ALU
 PE-folie, met PE-flap en ALU reflectie
 Film en PE avec réflexion ALU
 Polyethylen-Schutzfolie, Reflition ALU

Article number	Packing	Type
UFH-FOIL-ALU	50 m ²	50 m x 1 m - 3,0 mm

Type: UFH-FOIL-CLIP25



Clip for Film
 Dampfolienagel
 Agrafe pour film PE
 Foliendübel

Article number	Packing	Type
UFH-FOIL-CLIP25	100 pc.	25 mm

Type: UFH-PLUG80



Plug, shaft length 80 mm, Ø8 mm
 Montageplug, schachtlengte 80 mm, Ø8 mm
 Cheville de montage, longueur 80 mm, Ø8 mm
 Niederhaltedübel, Bohrer Ø 8 mm, Schaftlänge 80 mm

Article number	Packing	Type
UFH-PLUG80	100 pc.	80 mm, Ø8 mm

Type: UFH-ISOBORD-S



PE edge isolation with lapping strip and adhesive strip
 Randisolatie uit PE-schuim met PE-flap en kleefstroken
 Isolation périphérique en PE avec rabat et bande adhésif
 Randdämmstreifen aus PE mit Abrisskante und Klebestreifen

Article number	Packing	Type
UFH-ISOBORD-S	25 m	150 x 8 mm



Type: UFH-ISOBORD-G



PE edge isolation with lapping strip and adhesive strip for liquid floors
 Randisolatie voor gietvloeren uit PE-schuim met flap en kleefstroken
 Isolation périphérique en PE avec rabat et bande adhésif, pour chape anhydrite
 Randdämmstreifen aus PE mit Abrisskante und Klebestreifen, für Fliessestrich

Article number	Packing	Type
UFH-ISOBORD-G	25 m	150 mm x 8 mm

Type: UFH-DP200



PE expansion joint with self-adhesive rail
 Uitzettingsvoeg uit PE-schuim met zelfklevende rail
 Joint de dilatation en PE avec bande adhésive
 Dehnungsfuge aus PE mit Klebestreifen

Article number	Packing	Type
UFH-DP200	2 m	2000 mm x 100 mm x 8 mm

Type: UFH-DH40



Protection sleeve for expansion joint
 Voegdoorganghuls
 Gaine de protection pour joint de dilatation
 Schutzrohre für Dehnungsfugen

Article number	Packing	Type
UFH-DH40	100 pc.	400 mm

Type: UFH-BEND



Bend guide for pipe
 Geleidingsbocht voor buis
 Courbe pour tube
 Rohrführungsbogen

Article number	Packing	Type
UFH-BEND1218	1 pc.	Ø 12 - 18 mm
UFH-BEND20	1 pc.	Ø 20 mm

- 1
- 2
- 3
- 4
- 5
- 6
- 7
- 8
- 9
- 10
- 11



A. SYSTEMS

Type: UFH-ADN10



Additive for screed (min. pipe covering 45 mm)

Toevoegmiddel voor zandcementvloer (min. buisoverdking 45 mm)

Additif pour chape de ciment (min. épaisseur de chape au-dessus du tube 45 mm)

Estrichzusatz (min. Rohrüberdeckung 45 mm)

Article number	Packing	Type
UFH-ADN10	10 L	

1

2

3

4

5

6

7

8

9

10

11

B. MANIFOLDS



Type: UFH-06-MD



Manifold brass, adjustable, with flow meters
 Verdeler messing, regelbaar, met debietmeting
 Collecteur en laiton, réglable, avec débitmètres
 Verteiler aus Messing, regelbar, mit Durchflussmengenmesser

Article number	Packing	Type
UFH-060502-MD	1 pc.	1"M - 2 x 3/4"
UFH-060503-MD	1 pc.	1"M - 3 x 3/4"
UFH-060504-MD	1 pc.	1"M - 4 x 3/4"
UFH-060505-MD	1 pc.	1"M - 5 x 3/4"
UFH-060506-MD	1 pc.	1"M - 6 x 3/4"
UFH-060507-MD	1 pc.	1"M - 7 x 3/4"
UFH-060508-MD	1 pc.	1"M - 8 x 3/4"
UFH-060509-MD	1 pc.	1"M - 9 x 3/4"
UFH-060510-MD	1 pc.	1"M - 10 x 3/4"
UFH-060511-MD	1 pc.	1"M - 11 x 3/4"
UFH-060512-MD	1 pc.	1"M - 12 x 3/4"

Type: UFH-06-MR



Manifold brass, adjustable
 Verdeler messing, regelbaar
 Collecteur en laiton, réglable
 Verteiler aus Messing, regelbar

Article number	Packing	Type
UFH-060502-MR	1 pc.	1"M - 2 x 3/4"
UFH-060503-MR	1 pc.	1"M - 3 x 3/4"
UFH-060504-MR	1 pc.	1"M - 4 x 3/4"
UFH-060505-MR	1 pc.	1"M - 5 x 3/4"
UFH-060506-MR	1 pc.	1"M - 6 x 3/4"
UFH-060507-MR	1 pc.	1"M - 7 x 3/4"
UFH-060508-MR	1 pc.	1"M - 8 x 3/4"
UFH-060509-MR	1 pc.	1"M - 9 x 3/4"
UFH-060510-MR	1 pc.	1"M - 10 x 3/4"
UFH-060511-MR	1 pc.	1"M - 11 x 3/4"
UFH-060512-MR	1 pc.	1"M - 12 x 3/4"

Type: UFH-M-D



Flow meter for brass manifold
 Debietmeter voor messing verdeler
 Débitmètre pour collecteur en laiton
 Durchflussmengenanzeiger für Verteiler aus Messing

Article number	Packing	Type
UFH-M-D	1 pc.	

B. MANIFOLDS

Type: UFH-PGKTA



Pump unit A label pump with consistent temperature control
Pompgroep A-label met regeling voor constante temperatuur
Kit pompe label A avec régulation de température constante
Konstanttemperaturregelung mit A-Pumpe

Article number	Packing	Type
UFH-PGKTA	1 pc.	1" F / 27°C - 42°C

Type: UFH-PGKTA-TH



Thermostatic sensor UFH-PGKTA
Thermostaat kop voor UFH-PGKTA
Tête thermostatique UFH-PGKTA
Thermostatkopf UFH-PGKTA

Article number	Packing	Type
UFH-PGKTA-TH	1 pc.	

Type: UFH-GKT



Unit with consistent temperature control without pump
Groep met regeling voor constante temperatuur zonder pomp
Kit avec régulation de température constante sans pompe
Konstanttemperaturregelung ohne Pump

Article number	Packing	Type
UFH-GKT	1 pc.	1" F / 27°C - 42°C

Type: UFH-BT-M



1" F ball valve with 1" F swivel nut, washer and thermometer
Kogelkraan 1" F met wartelmoer 1" F , dichting en thermometer
Vanne à sphère 1" F avec écrou 1" F, joint et thermomètre
Kugelhahnset 1" IG mit Mutter 1" IG , Dichtung und Thermometer

Article number	Packing	Type
UFH-BTM0606-M	1 set (2 pc.)	1" F x 1" F / 0 - 60 °

B. MANIFOLDS



Type: UFH-B-M



1" F ball valve with 1" F swivel nut and washer
Kogelkraan 1" F met wartelmoer 1" F en dichting
Vanne à sphère 1" F avec écrou 1" F et joint plat
Kugelhahnset 1" IG mit Mutter 1" IG und Dichtung

Article number	Packing	Type
UFH-B0606-M	1 set (2 pc.)	1" F x 1" F

Type: UFH-ESK-M



1" F end cap with nut, washer, ball valve and air vent 3/8"
Eindstuk 1" F met moer, dichting, kogelkraan en ontluftingskraan 3/8"
Bouchon terminal 1" F avec écrou, vanne à sphère, joint et purgeur 3/8"
Verteilerendstückset 1" IG mit Mutter und Dichtung, Enlüftung 3/8", Kugelhahnset, Entleerung 1/2"

Article number	Packing	Type
UFH-ESK060303-M	1 set (2 pc.)	1" F x 1/2" x 3/8"

Type: UFH-AO-MZ



Automatic air vent, without check valve
Automatische ontlufter, zonder waterslot
Purgeur automatique, sans serrure d'eau
Schnellentlüfter mit vertikaler Entlüftung, ohne Wasserabspernung

Article number	Packing	Type
UFH-AO03-MZ	1 pc.	3/8"

Type: UFH-TM-M



Thermometer for return with EK connections
Thermometer voor terugvoer met euroconus aansluitingen
Retour thermomètre avec raccordement eurocone
Thermometer zum Anschluss Rücklauf mit Eurokonus-Anschlüssen

Article number	Packing	Type
UFH-TM050-M	1 pc.	3/4" - 3/4" EK / 0

Type: UFH-BS-M



End cap with washer
Blindstop
Bouchon
Kappe mit Dichtung

Article number	Packing	Type
UFH-BS05-M	1 pc.	3/4"

B. MANIFOLDS

Type: UFH-06-RVSD



Manifold Stainless steel, adjustable, with flow meters
 Verdeler roestvrij staal, regelbaar, met debietmeting
 Collecteur acier inoxydable, réglable, avec débitmètres
 Verteiler aus Edelstahl, regelbar, mit Durchflussmengenmesser

Article number	Packing	Type
UFH-060502-RVSD	1 pc.	1"M - 2 x 3/4" EK
UFH-060503-RVSD	1 pc.	1"M - 3 x 3/4" EK
UFH-060504-RVSD	1 pc.	1"M - 4 x 3/4" EK
UFH-060505-RVSD	1 pc.	1"M - 5 x 3/4" EK
UFH-060506-RVSD	1 pc.	1"M - 6 x 3/4" EK
UFH-060507-RVSD	1 pc.	1"M - 7 x 3/4" EK
UFH-060508-RVSD	1 pc.	1"M - 8 x 3/4" EK
UFH-060509-RVSD	1 pc.	1"M - 9 x 3/4" EK
UFH-060510-RVSD	1 pc.	1"M - 10 x 3/4" EK
UFH-060511-RVSD	1 pc.	1"M - 11 x 3/4" EK
UFH-060512-RVSD	1 pc.	1"M - 12 x 3/4" EK

Type: UFH-BT-VN



1" F ball valve with 1" F swivel nut, washer and thermometer, nickel-plated
 Kogelkraan 1" F met wartelmoer 1" F, dichting en thermometer, vernikkeld
 Vanne à sphère 1" F avec écrou 1" F, joint et thermomètre, nickelé
 Kugelhahnset 1" IG mit Mutter 1" IG, Dichtung und Thermometer, vernickelt

Article number	Packing	Type
UFH-BTM0606-VN	1 set (2 pc.)	1" F x 1" F

Type: UFH-B-VN



1" F ball valve with 1" F swivel nut and washer, nickel-plated
 Kogelkraan 1" F met wartelmoer 1" F en dichting, vernikkeld
 Vanne à sphère 1" F avec écrou 1" F et joint, nickelé
 Kugelhahnset 1" IG mit Mutter 1" IG und Dichtung, vernickelt

Article number	Packing	Type
UFH-B0606-VN	1 set (2 pc.)	1" F x 1" F / 0 - 60 °

Type: UFH-ESK-VN



1" F end cap with nut, washer, ball valve and air vent 3/8", nickel-plated
 Eindstuk 1" F met moer, dichting, kogelkraan en ontluichtingskraan 3/8", vernikkeld
 Bouchon terminal 1" F avec écrou, joint et purgeur 3/8", nickelé
 Verteilerendstückset 1" IG mit Mutter und Dichtung, Entlüftung 3/8", Kugelhahnset, vernickelt

Article number	Packing	Type
UFH-ESK060303-VN	1 set (2 pc.)	1" F x 1/2" x 3/8"

B. MANIFOLDS



Type: UFH-MDK

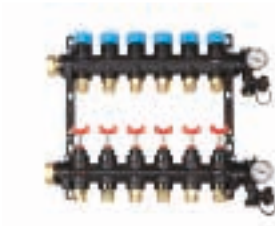

Manifold composite, adjustable with flow meter, thermometer washer and air vent
Composiet verdeler, regelbaar met debietmeting, thermometer, vul- en aftapkraan, ontluchter

Collecteur composite, réglable avec débitmètre, thermomètre, purge et purgeur d'air

Verteiler Composite, regelbaar mit Durchflussmengenmesser, Thermomesser, Entleerung und Entlüfter

Article number	Packing	Type
UFH-0605MDK02	1 pc.	1" - 2 x 3/4"
UFH-0605MDK03	1 pc.	1" - 3 x 3/4"
UFH-0605MDK04	1 pc.	1" - 4 x 3/4"
UFH-0605MDK05	1 pc.	1" - 5 x 3/4"
UFH-0605MDK06	1 pc.	1" - 6 x 3/4"
UFH-0605MDK07	1 pc.	1" - 7 x 3/4"
UFH-0605MDK08	1 pc.	1" - 8 x 3/4"
UFH-0605MDK09	1 pc.	1" - 9 x 3/4"
UFH-0605MDK10	1 pc.	1" - 10 x 3/4"
UFH-0605MDK11	1 pc.	1" - 11 x 3/4"
UFH-0605MDK12	1 pc.	1" - 12 x 3/4"

Type: UFH-MDK-CON



Composite connector for MDK manifold

Composiet verbinder voor MDK verdeler

Connecteur en composite pour collecteur MDK

Composiet Verbinder für MDK Verteiler

Article number	Bag / Box	Type
UFH-MDK-CON	1 pc. / 50 pc.	

Type: UFH-BM-VN



Ball valve with gasket, nickel-plated

Kogelkraan met dichting, vernikkeld

Vanne à sphère et joint, nickelé

Kugelhahnset, vernickelt

Article number	Packing	Type
UFH-B0605-VN	1 set (2 pc.)	3/4" x 1"
UFH-BM0606-VN	1 set (2 pc.)	1" x 1"

B. MANIFOLDS

Type: UFH-CDP



Manifold composite, adjustable with flow meter and A-pump
 Composiet verdeler, regelbaar met debietmeting en A-pomp
 Collecteur composite, réglable avec débitmètre et pompe label A
 Verteiler Composite, regelbar mit Durchflussmengenmesser und A-Pumpe

Article number	Packing	Type
UFH-0405CDP01	1 pc.	1/2" - 1 x 3/4"
UFH-0405CDP02	1 pc.	1/2" - 2 x 3/4"
UFH-0405CDP03	1 pc.	1/2" - 3 x 3/4"
UFH-0405CDP04	1 pc.	1/2" - 4 x 3/4"
UFH-0405CDP05	1 pc.	1/2" - 5 x 3/4"
UFH-0405CDP06	1 pc.	1/2" - 6 x 3/4"
UFH-0505CDP07	1 pc.	3/4" - 7 x 3/4"
UFH-0505CDP08	1 pc.	3/4" - 8 x 3/4"
UFH-0505CDP09	1 pc.	3/4" - 9 x 3/4"
UFH-0505CDP10	1 pc.	3/4" - 10 x 3/4"
UFH-0505CDP11	1 pc.	3/4" - 11 x 3/4"
UFH-0505CDP12	1 pc.	3/4" - 12 x 3/4"
UFH-0505CDP13	1 pc.	3/4" - 13 x 3/4"
UFH-0505CDP14	1 pc.	3/4" - 14 x 3/4"
UFH-0505CDP15	1 pc.	3/4" - 15 x 3/4"
UFH-0505CDP16	1 pc.	3/4" - 16 x 3/4"

Also available with Active Flow Control

Type: UFH-CD

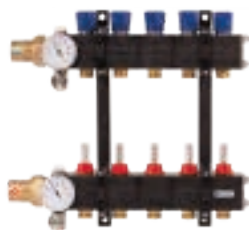

Manifold composite, adjustable with flow meter
 Composiet verdeler, regelbaar met debietmeting
 Collecteur composite, réglable avec débitmètre
 Verteiler Composite, regelbar mit Durchflussmengenmesser

Article number	Packing	Type
UFH-0605CD01	1 pc.	1" - 1 x 3/4"
UFH-0605CD02	1 pc.	1" - 2 x 3/4"
UFH-0605CD03	1 pc.	1" - 3 x 3/4"
UFH-0605CD04	1 pc.	1" - 4 x 3/4"
UFH-0605CD05	1 pc.	1" - 5 x 3/4"
UFH-0605CD06	1 pc.	1" - 6 x 3/4"
UFH-0605CD07	1 pc.	1" - 7 x 3/4"
UFH-0605CD08	1 pc.	1" - 8 x 3/4"
UFH-0605CD09	1 pc.	1" - 9 x 3/4"
UFH-0605CD10	1 pc.	1" - 10 x 3/4"
UFH-0605CD11	1 pc.	1" - 11 x 3/4"
UFH-0605CD12	1 pc.	1" - 12 x 3/4"
UFH-0605CD13	1 pc.	1" - 13 x 3/4"
UFH-0605CD14	1 pc.	1" - 14 x 3/4"
UFH-0605CD15	1 pc.	1" - 15 x 3/4"
UFH-0605CD16	1 pc.	1" - 16 x 3/4"
UFH-0605CD17	1 pc.	1" - 17 x 3/4"
UFH-0605CD18	1 pc.	1" - 18 x 3/4"
UFH-0605CD19	1 pc.	1" - 19 x 3/4"
UFH-0605CD20	1 pc.	1" - 20 x 3/4"

Also available with Active Flow Control

B. MANIFOLDS

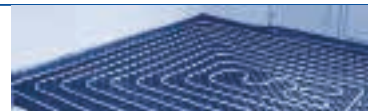

Type: UFH-CAF



Manifold composite, adjustable with active flow control
 Composiet verdeler, regelbaar met active flow control
 Collecteur composite, réglable avec active flow control
 Verteiler Composite, regelbar mit active flow control

Article number	Packing	Type
UFH-0605CAF01	1 pc.	1" - 1 x 3/4"
UFH-0605CAF04	1 pc.	1" - 4 x 3/4"
UFH-0605CAF07	1 pc.	1" - 7 x 3/4"

TILL EXHAUSTION OF STOCK

Type: UFH-CDWE



Manifold composite project che with heat exchanger and dirt separator
 Composiet verdeler project cwe met warmtewisselaar en vuilafscheider
 Collecteur composite projet cev avec échangeur de chaleur et séparateur de boue
 Verteiler Composite projt cwa mit Wärmetauscher und Schlammabscheider

Article number	Packing	Type
UFH-0505CDWE01	1 pc.	3/4" - 1 x 3/4"
UFH-0505CDWE03	1 pc.	3/4" - 3 x 3/4"
UFH-0505CDWE06	1 pc.	3/4" - 6 x 3/4"
UFH-0505CDWE08	1 pc.	3/4" - 8 x 3/4"
UFH-0505CDWE09	1 pc.	3/4" - 9 x 3/4"

TILL EXHAUSTION OF STOCK

Type: UFH-CP



A-pump unit for composite collector
 Pompunit composiet verdeler, met A-pomp
 Kit pompe-A pour collecteur composite
 A-Pump Unit für Composite Verteiler

Article number	Packing	Type
UFH-CP	1 pc.	

B. MANIFOLDS

Type: UFH-S



Steel collector with pump
Stalen verdeler met pomp
Collecteur en acier avec pompe
Verteiler Stahl mit Pump

Article number	Packing	Type
UFH-0405S01	1 pc.	1/2" - 1 x 3/4"
UFH-0405S02	1 pc.	1/2" - 2 x 3/4"
UFH-0405S03	1 pc.	1/2" - 3 x 3/4"
UFH-0405S04	1 pc.	1/2" - 4 x 3/4"
UFH-0405S06	1 pc.	1/2" - 6 x 3/4"
UFH-0505S08	1 pc.	3/4" - 8 x 3/4"
UFH-0505S09	1 pc.	3/4" - 9 x 3/4"
UFH-0505S10	1 pc.	3/4" - 10 x 3/4"
UFH-0505S11	1 pc.	3/4" - 11 x 3/4"
UFH-0505S12	1 pc.	3/4" - 12 x 3/4"
UFH-0505S13	1 pc.	3/4" - 13 x 3/4"
UFH-0505S14	1 pc.	3/4" - 14 x 3/4"
UFH-0505S15	1 pc.	3/4" - 15 x 3/4"
UFH-0505S16	1 pc.	3/4" - 16 x 3/4"

TILL EXHAUSTION OF STOCK

Type: UFH-SECO



Steel collector with A-pump
Stalen verdeler met A-pomp
Collecteur en acier avec pompe label A
Verteiler Stahl mit A-Pump

Article number	Packing	Type
UFH-0405SECO01	1 pc.	1/2" - 1 x 3/4"
UFH-0405SECO02	1 pc.	1/2" - 2 x 3/4"
UFH-0405SECO03	1 pc.	1/2" - 3 x 3/4"
UFH-0405SECO04	1 pc.	1/2" - 4 x 3/4"
UFH-0405SECO05	1 pc.	1/2" - 5 x 3/4"
UFH-0405SECO06	1 pc.	1/2" - 6 x 3/4"
UFH-0505SECO07	1 pc.	3/4" - 7 x 3/4"
UFH-0505SECO08	1 pc.	3/4" - 8 x 3/4"
UFH-0505SECO09	1 pc.	3/4" - 9 x 3/4"
UFH-0505SECO10	1 pc.	3/4" - 10 x 3/4"
UFH-0505SECO11	1 pc.	3/4" - 11 x 3/4"
UFH-0505SECO12	1 pc.	3/4" - 12 x 3/4"
UFH-0505SECO13	1 pc.	3/4" - 13 x 3/4"
UFH-0505SECO14	1 pc.	3/4" - 14 x 3/4"
UFH-0505SECO15	1 pc.	3/4" - 15 x 3/4"
UFH-0505SECO16	1 pc.	3/4" - 16 x 3/4"

B. MANIFOLDS



Type: UFH-SSTN



Steel collector with pump, district heating nuon and eneco
 Stalen verdeler met pomp, stadsverwarming nuon en eneco
 Collecteur en acier avec pompe, chauffage urbain nuon et eneco
 Verteiler Stahl mit Pump, Fernheizung nuon und eneco

Article number	Packing	Type
UFH-0405SSTN01	1 pc.	1/2" - 1 x 3/4"
UFH-0405SSTN02	1 pc.	1/2" - 2 x 3/4"
UFH-0405SSTN03	1 pc.	1/2" - 3 x 3/4"
UFH-0405SSTN04	1 pc.	1/2" - 4 x 3/4"
UFH-0405SSTN05	1 pc.	1/2" - 5 x 3/4"
UFH-0405SSTN06	1 pc.	1/2" - 6 x 3/4"
UFH-0505SSTN07	1 pc.	3/4" - 7 x 3/4"
UFH-0505SSTN08	1 pc.	3/4" - 8 x 3/4"
UFH-0505SSTN09	1 pc.	3/4" - 9 x 3/4"
UFH-0505SSTN10	1 pc.	3/4" - 10 x 3/4"
UFH-0505SSTN11	1 pc.	3/4" - 11 x 3/4"
UFH-0505SSTN12	1 pc.	3/4" - 12 x 3/4"

Type: UFH-SSTE



Steel collector with pump, district heating essent
 Stalen verdeler met pomp, stadsverwarming essent
 Collecteur en acier avec pompe, chauffage urbain essent
 Verteiler Stahl mit Pump, Fernheizung essent

Article number	Packing	Type
UFH-0405SSTE01	1 pc.	1/2" - 1 x 3/4"
UFH-0405SSTE02	1 pc.	1/2" - 2 x 3/4"
UFH-0405SSTE03	1 pc.	1/2" - 3 x 3/4"
UFH-0405SSTE04	1 pc.	1/2" - 4 x 3/4"
UFH-0405SSTE05	1 pc.	1/2" - 5 x 3/4"
UFH-0405SSTE06	1 pc.	1/2" - 6 x 3/4"
UFH-0505SSTE07	1 pc.	3/4" - 7 x 3/4"
UFH-0505SSTE08	1 pc.	3/4" - 8 x 3/4"
UFH-0505SSTE09	1 pc.	3/4" - 9 x 3/4"
UFH-0505SSTE10	1 pc.	3/4" - 10 x 3/4"
UFH-0505SSTE11	1 pc.	3/4" - 11 x 3/4"
UFH-0505SSTE12	1 pc.	3/4" - 12 x 3/4"

B. MANIFOLDS

Type: UFH-LTV

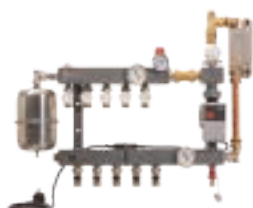

Steel collector with A-pump and plate heat exchanger (low temperature)
 Stalen verdeler met A-pomp en scheidingswisselaar voor LT toepassing
 Collecteur en acier avec pompe label A et échangeur à plaques (température basse)
 Verteiler Stahl mit A-Pump und Plattenwärmetauscher (niedrigen Temperaturen)

Article number	Packing	Type
UFH-0405LTV01	1 pc.	1/2" - 1 x 3/4"
UFH-0405LTV02	1 pc.	1/2" - 2 x 3/4"
UFH-0405LTV03	1 pc.	1/2" - 3 x 3/4"
UFH-0405LTV04	1 pc.	1/2" - 4 x 3/4"
UFH-0405LTV05	1 pc.	1/2" - 5 x 3/4"
UFH-0405LTV06	1 pc.	1/2" - 6 x 3/4"
UFH-0505LTV07	1 pc.	3/4" - 7 x 3/4"
UFH-0505LTV08	1 pc.	3/4" - 8 x 3/4"
UFH-0505LTV09	1 pc.	3/4" - 9 x 3/4"
UFH-0505LTV10	1 pc.	3/4" - 10 x 3/4"
UFH-0505LTV11	1 pc.	3/4" - 11 x 3/4"
UFH-0505LTV12	1 pc.	3/4" - 12 x 3/4"

Type: UFH-TV0628



Thermostatic valve 6 - 28°C, built in
 Thermostaatventiel 6 - 28°C, inbouw
 Vanne thermostatique de température ambiante entre 6 - 28 °C, encastré
 Thermostatventil 6-28°C, Unterputz

Article number	Packing	Type
UFH-TV0628	1 pc.	6 - 28°C

TILL EXHAUSTION OF STOCK

Type: UFH-MAXB55



Maximum temperature safety cut-out switch
 Maximaalbeveiligingsschakelaar
 Interrupteur de protection maximal
 Maximalschutzschalter

Article number	Packing	Type
UFH-MAXB55	1 pc.	Max. 55 °C

TILL EXHAUSTION OF STOCK

Type: UFH-MAX95



Maximum temperature safety cut-out switch 50 - 95°C
 Maximaalthermostaat, 50 - 95°C
 Thermostat de sécurité, 50 - 95 °C
 Maximalschutzschalter, 50 - 95 °C

Article number	Packing	Type
UFH-MAX95	1 pc.	50 - 95°C - 15A / 230V

TILL EXHAUSTION OF STOCK

B. MANIFOLDS

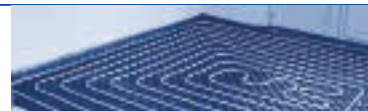

Type: UFH-C191645



Thermostatic sensor 10/60°C with short probe
 Thermostaat voeler 10/60°C met korte sensor
 Tête thermostatique 10/60°C avec senseur court
 Thermostat 10/60°C mit kurze Fühler

Article number	Packing	Type
UFH-C191645		

Type: UFH-C191974 - 76



Circulator Wilo Yonos Para RS 15/6-RKA KU 130mm
 Circulator Wilo Yonos Para RS 15/6-RKA KU 130mm
 Circulateur Wilo Yonos Para RS 15/6-RKA KU 130mm
 Cirkulator Wilo Yonos Para RS 15/6-RKA KU 130mm

Article number	Packing	Type
UFH-C191974		1"
UFH-C191976		1 1/2"

Type: UFH-C192071



Safety thermostat incl. wire/plug
 Maximaal thermostaat incl. snoer/stker
 Thermostat de sécurité incl. fil/prise
 Maximal Thermostat incl. Snur/Stecker

Article number	Packing	Type
UFH-C192071	1 pc.	

Type: UFH-C191800



Thermometer with immersion sleeve 0/60 gr.
 Thermometer met dompelbuis temp 0/60 gr.
 Thermomètre temp. 0/60 gr. avec bulbe
 Thermometer mit Tauchhülse 0/60 gr.

Article number	Packing	Type
UFH-C191800	1 pc.	



C. CONTROL UNITS

- 1 WIRED CONTROL UNIT
- 2 BEKABELDE ZONEREGELING
- 3 RÉGULATEURS DE ZONE CÂBLÉS
- 4
- 5
- 6
- 7
- 8
- 9
- 10
- 11

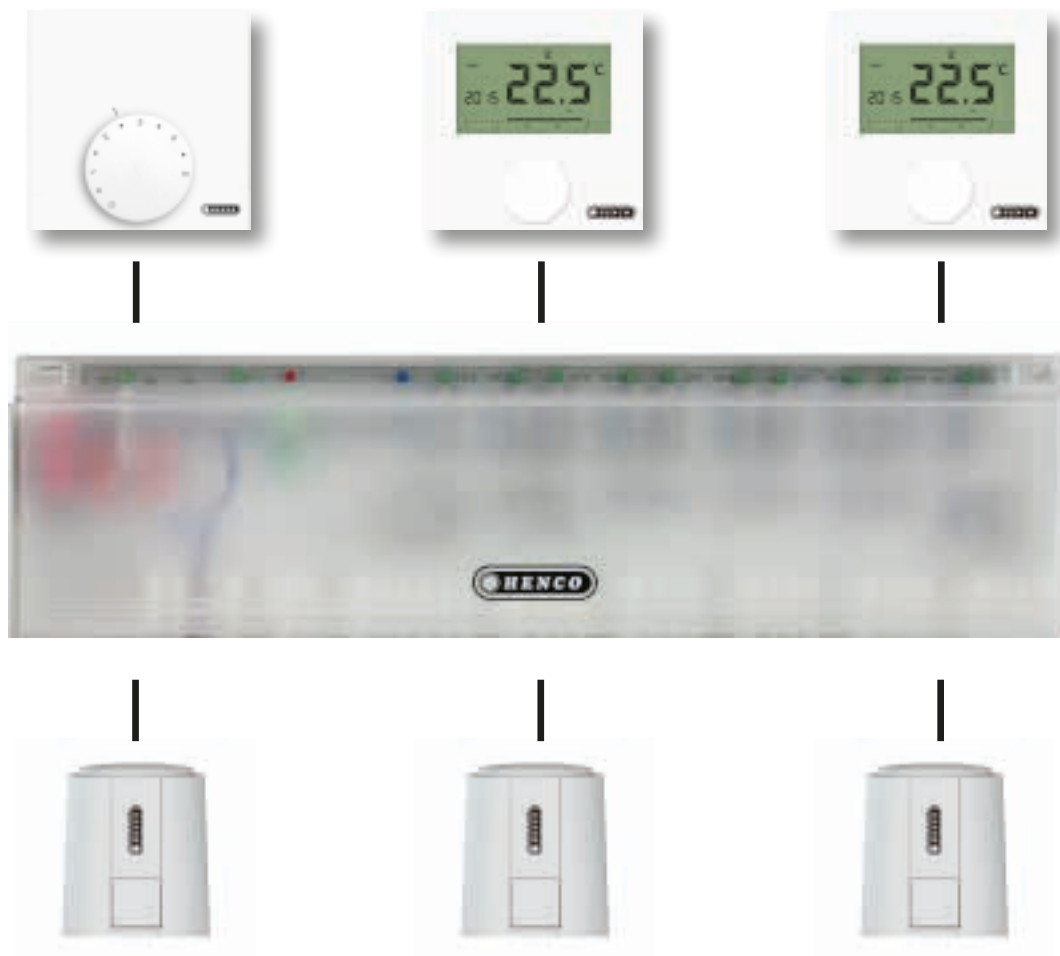

C. CONTROL UNITS

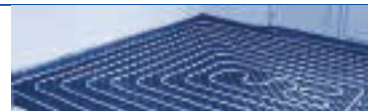

Type: CU-6ZONE-24V



Base module 6 zones, 24V transformator incl.
Basisstation 6 zonen, 24V transformator incl.
Base module 6 zones, 24V transformator incl.
Regelklemmleiste 6-Zonen, Basic, 24V incl Transformator.

Article number	Packing	Type
CU-6ZONE-24V	1 pc.	

Type: CU-6ZONE-230V



Base module 6 zones, 230V
Basismodule 6 zones, 230V
Module de base 6 zones, 230V
Regelklemmleiste 6-Zonen, Basic, 230V

Article number	Packing	Type
CU-6ZONE-230V	1 pc.	

Type: CU-DINRAIL



Din rail
Din rail
Din rail
Befestigungsschiene für Regelklemmleiste

Article number	Packing	Type
CU-DINRAIL	1 pc.	

Type: CU-6ZONEP-24V



Base module Plus 6 zones, 24V transformator incl. (heating/cooling with pump contact)
Basisstation Plus 6 zonen, 24V transformator incl. (verwarmen/koelen met pompsturing)
Base module Plus 6 zones, 24V transformator incl. (chauffer/refroidir avec contact circulateur)
Regelklemmleiste Plus 6-Zonen, Basic, 24V incl Transformator. (Heizung/Kühlung mit Pumpensteuerung)

Article number	Packing	Type
CU-6ZONEP-24V	1 pc.	

- 1
- 2
- 3
- 4
- 5
- 6
- 7
- 8
- 9
- 10
- 11

C. CONTROL UNITS

Type: CU-6ZONEP-230V



Base module Plus 6 zones, 230V transformator incl. (heating/cooling with pump contact)

Basisstation Plus 6 zonen, 230V transformator incl. (verwarmen/koelen met pompsturing)

Base module Plus 6 zones, 230V transformator incl. (chauffer/refroidir avec contact circulateur)

Regelklemmleiste Plus 6-Zonen, Basic, 230V incl Transformator. (Heizung/Kühlung mit Pumpensteuerung)

Article number	Packing	Type
CU-6ZONE-230V	1 pc.	

Type: CU-DINRAIL



Din rail

Din rail

Din rail

Befestigungsschiene für Regelklemmleiste

Article number	Packing	Type
CU-DINRAIL	1 pc.	

Type: CU-6ZONEK-24V



Base module Comfort 6 zones, 24V transformator (heating/cooling with pump contact and boiler contact)

Basismodule Comfort 6 zones, 24V met transformator incl. (verwarmen/koelen met pompsturing en ketelsturing)

Module de base Comfort 6 zones, 24V transformateur incl. (chauffer/refroidir avec contact circulateur et contact boiler))

Regelklemmleiste 6-Zonen, Komfort, 24V incl Transformator (Heizung/Kühlung mit Pumpensteuerung und Boilersteuerung)

Article number	Packing	Type
CU-6ZONEK-24V	1 pc.	

Type: CU-6ZONEK-230V



Base module Comfort 6 zones, 230V transformator (heating/cooling with pump contact and boiler contact)

Basismodule Comfort 6 zones, 230V met transformator incl. (verwarmen/koelen met pompsturing en ketelsturing)

Module de base Comfort 6 zones, 230V transformateur incl. (chauffer/refroidir avec contact circulateur et contact boiler))

Regelklemmleiste 6-Zonen, Komfort, 230V incl Transformator (Heizung/Kühlung mit Pumpensteuerung und Boilersteuerung)

Article number	Packing	Type
CU-6ZONEK-230V	1 pc.	

C. CONTROL UNITS



Type: CU-10ZONEK-24V



Base module Comfort 10 zones, 24V transformator (heating/cooling with pump contact and boiler contact)

Basismodule Comfort 10 zones, 24V met transformator incl. (verwarmen/koelen met pompsturing en ketelsturing)

Module de base Comfort 10 zones, 24V transformateur incl. (chauffer/refroidir avec contact circulateur et contact boiler))

Regelklemmleiste 10-Zonen, Komfort, 24V incl Transformator (Heizung/Kühlung mit Pumpensteuerung und Boilersteuerung)

Article number	Packing	Type
CU-10ZONEK-24V	1 pc.	

Type: CU-10ZONEK-230V



Base module Comfort 10 zones, 230V transformator (heating/cooling with pump contact and boiler contact)

Basismodule Comfort 10 zones, 230V met transformator incl. (verwarmen/koelen met pompsturing en ketelsturing)

Module de base Comfort 10 zones, 230V transformateur incl. (chauffer/refroidir avec contact circulateur et contact boiler))

Regelklemmleiste 10-Zonen, Komfort, 230V incl Transformator (Heizung/Kühlung mit Pumpensteuerung und Boilersteuerung)

Article number	Packing	Type
CU-10ZONEK-230V	1 pc.	

Type: CU-DINRAIL



Din rail

Din rail

Din rail

Befestigungsschiene für Regelklemmleiste

Article number	Packing	Type
CU-DINRAIL	1 pc.	

Type: CU-REGB

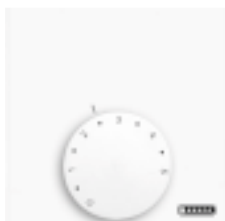

Analog thermostat

Regelaar analog

Thermostat analogue

Raumthermostat, analog

Article number	Packing	Type
CU-REGB-24V	1 pc.	24V
CU-REGB-230V	1 pc.	230V

C. CONTROL UNITS

Type: CU-REGB-HC



Analog thermostat, heating/cooling
 Regelaar analoog, verwarmen/koelen
 Thermostat analogue, chauffer et refroidir
 Raumthermostat, analog, heizen und kühlen

Article number	Packing	Type
CU-REGB-HC24V	1 pc.	24V
CU-REGB-HC230V	1 pc.	230V

Type: CU-REGK



LCD comfort thermostat 24V, heating/cooling
 Regelaar LCD comfort, 24V, verwarmen/koelen
 LCD comfort thermostat 24V, chauffer et refroidir
 Raumthermostat, LCD 24V, heizen und kühlen

Article number	Packing	Type
CU-REGK-24V	1 pc.	24V
CU-REGK-230V	1 pc.	230V

Type: CU-REGC



LCD control thermostat 230V, heating/cooling + clock program
 Regelaar LCD control, 230V, verwarmen/koelen + klokfunctie
 LCD control thermostat 230v, chauffer et refroidir + programmation
 Raumthermostat, LCD, Control, 230V, heizen und kühlen + Zeitsangabe

Article number	Packing	Type
CU-REGC-24V	1 pc.	24V
CU-REGC-230V	1 pc.	230V

Type: CU-ACT



Act with cable 1m
 Act met vaste kabel 1m
 Act avec cable 1m
 Stellantrieb Kabel 1m

Article number	Packing	Type
CU-ACT-24V	1 pc.	24V
CU-ACT-230V	1 pc.	230V



Type: CU-ACT-PLUG



Act for plugcable
Act voor steekbare kabel
Act pour plugcable
Sellantrieb für Stecker

Article number	Packing	Type
CU-ACT-24V-PLUG	1 pc.	24V
CU-ACT-230V-PLUG	1 pc.	230V

Type: CU-PLUGCABLE



Act plugcable
Losse kabel voor act
Act plugcable
Stecker Leitung

Article number	Packing	Type
CU-PLUGCABLE-2M	1 pc.	2 m
CU-PLUGCABLE-5M	1 pc.	5 m
CU-PLUGCABLE-15M	1 pc.	15 m

1

2

3

4

5

6

7

8

9

10

11



C. CONTROL UNITS

- 1 **WIRELESS CONTROL UNIT (HEATING / COOLING)**
- 2 **DRAADLOZE ZONEREGELING (VERWARMEN / KOELLEN)**
- 3 **RÉGULATEURS DE ZONE SANS FIL (CHAUFFAGE / REFRIGÉRISSSEMENT)**
- 4 **REGELVERTEILER FUNK (HEIZEN / KÜHLEN)**
- 5
- 6
- 7
- 8
- 9
- 10
- 11



C. CONTROL UNITS

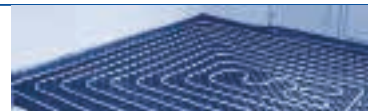

Type: CU-MONO-RF



One zone module 230V
 Module 1 zone 230V
 Module zone individuelle 230V
 Regelklemmleiste 1-Zone, 230V

Article number	Packing	Type
CU-MONO-RF	1 pc.	

Type: CU-8ZONE-RF



Base module 8 zones, 230V LAN DIN rail incl. (heating/cooling)
 Basismodule 8 zones, 230V met LAN en DIN rail (verwarmen/koelen)
 Module de base 8 zones, 230V LAN + DIN rail incl. (chauffer/refroidir)
 Regelklemmleiste 8-Zonen, Funk 230V incl. Befestigungsschiene (heizen und kühlen)

Article number	Packing	Type
CU-8ZONE-RF	1 pc.	

Type: CU-8ZONEB-RF



Base module 8 zones, 230V DIN rail incl. (heating/cooling)
 Basismodule 8 zones, 230V inclusief DIN rail (verwarmen/koelen)
 Module de base 8 zones, 230V DIN rail incl. (chauffer/refroidir)
 Regelklemmleiste 8-Zonen, incl. Befestigungsschiene (heizen und kühlen)

Article number	Packing	Type
CU-8ZONEB-RF	1 pc.	

Type: CU-12ZONE-RF



Base module 12 zones, 230V LAN din rail incl. (heating/cooling)
 Basismodule 12 zones, 230V met LAN en DIN rail (verwarmen/koelen)
 Module de base 12 zones, 230V LAN + DIN rail incl. (chauffer/refroidir)
 Regelklemmleiste 12-Zonen, Funk 230V incl. Befestigungsschiene (heizen und kühlen)

Article number	Packing	Type
CU-12ZONE-RF	1 pc.	

Type: CU-REGB-RF



Analog thermostat, 0-5 incl. batt (heating/cooling)
 Regelaar analog, met instelling 0-5 incl. batt. (verwarmen/koelen)
 Thermostat analogue, 0-5 incl. batt (chauffer/refroidir)
 Raumthermostat analog Funk incl. Batterie (heizen und kühlen)

Article number	Packing	Type
CU-REGB-RF	1 pc.	

- 1
- 2
- 3
- 4
- 5
- 6
- 7
- 8
- 9
- 10
- 11

C. CONTROL UNITS

Type: CU-REGC-RF



Thermostat LCD, optional ext. sensor
 Regelaar LCD, met aansl. voor ext. sensor
 thermostat LCD, option ext. sens
 Raumthermostat LCD Funk, optional mit externem Sensor

Article number	Packing	Type
CU-REGC-RF	1 pc.	

Type: CU-REGS-RF



Tamper free sensor
 Ruimte sensor zonder instelling
 Sonde sans bouton
 Raumthermostat 24V, Behördenmodell

Article number	Packing	Type
CU-REGS-RF	1 pc.	

Type: CU-REPEAT



Repeater
 Repeater
 Repeater
 Repeater

Article number	Packing	Type
CU-REPEAT	1 pc.	

Type: CU-ANT



Antenne
 Antenne
 Antenne
 Antenne

Article number	Packing	Type
CU-ANT	1 pc.	

Type: CU-SENS



External sensor
 Externe sensor
 Sonde externe
 Externer Sensor

Article number	Packing	Type
CU-SENS	1 pc.	3 m

C. CONTROL UNITS



Type: CU-ACT-230V-PLUG



Act for plugcable, 230V
Act voor steekbare kabel, 230V
Act pour plugcable, 230V
Stellantrieb für Stecker, 230V

Article number	Packing	Type
CU-ACT-230V-PLUG	1 pc.	

Type: CU-PLUGCABLE



Act plugcable
Losse kabel voor act
Act plugcable
Stecker Leitung

Article number	Packing	Type
CU-PLUGCABLE-2M	1 pc.	2 m
CU-PLUGCABLE-5M	1 pc.	5 m
CU-PLUGCABLE-15M	1 pc.	15 m

Type: UFH-H5004



Copper shroud for UFH-SENSOR
Koperen huls voor UFH-SENSOR
Doigt de gant pour UFH-SENSOR
Kupferhulse für UFH-SENSOR

Article number	Packing	Type
UFH-H5004	1 pc.	50 mm x 1/2"

Type: UFH-ANC



Valve
Zoneventiel
Vanne
Ventil

Article number	Packing	Type
UFH-ANC-05	1 pc.	2 x 3/4" - M30x1,5 - Kv 2
UFH-ANC-06	1 pc.	2 x 1" - M30x1,5 - Kv 4,5

D. GEOTHERMAL

Type: UFH-GB



Hencologique basket type 1
Hencologische korf type 1
Panier hencologique type 1
Hencologische Basket Type 1

Article number	Packing	Type
UFH-GB26100	1 pc.	110cm x 200cm

Type: UFH-CDGEO



Manifold composite GEO, adjustable with flowmeter
Composiet verdeler GEO, regelbaar met debietmeting
Collecteur composite GEO, réglable avec débitmètre
Verteiler Composite GEO, regelbar mit Durchflussmengenmesser

Article number	Packing	Type
UFH-0626CD01	1 pc.	1" - 1 x Ø26
UFH-0626CD02	1 pc.	1" - 2 x Ø26
UFH-0626CD03	1 pc.	1" - 3 x Ø26
UFH-0626CD04	1 pc.	1" - 4 x Ø26
UFH-0626CD05	1 pc.	1" - 5 x Ø26
UFH-0626CD06	1 pc.	1" - 6 x Ø26
UFH-0626CD07	1 pc.	1" - 7 x Ø26
UFH-0626CD08	1 pc.	1" - 8 x Ø26



- 1
- 2
- 3
- 4
- 5
- 6
- 7
- 8
- 9
- 10
- 11

Type: UFH-CAB-I



Recessed manifold cabinet, RAL 9016
 Verdelerkast voor inbouw, RAL 9016
 Boîte à encastrer pour collecteurs, RAL 9016
 Verteilerschrank Unterputz, RAL 9016

Article number	Packing	Type
UFH-CAB-I400 *	1 pc.	400x700-800x112-152mm (4 circ.)
UFH-CAB-I600 *	1 pc.	600x700-800x112-152mm (8 circ.)
UFH-CAB-I800 *	1 pc.	800x700-800x112-152mm (12 circ.)
UFH-CAB-I1000 *	1 pc.	1000x700-800x112-152mm (16 circ.)

** Only in combination with brass manifolds*

Type: UFH-CAB-O



Surface mount manifold cabinet, RAL 9016
 Verdelerkast voor opbouw, RAL 9016
 Boîte à poser pour collecteurs, RAL 9016
 Verteilerschrank Aufputz, RAL 9016

Article number	Packing	Type
UFH-CAB-O400 *	1 pc.	400x720x112mm (4 circ.)
UFH-CAB-O600 *	1 pc.	600x720x112mm (8 circ.)
UFH-CAB-O800 *	1 pc.	800x720x112mm (12 circ.)
UFH-CAB-O1000 *	1 pc.	1000x720x112mm (16 circ.)

** Only in combination with brass manifolds*

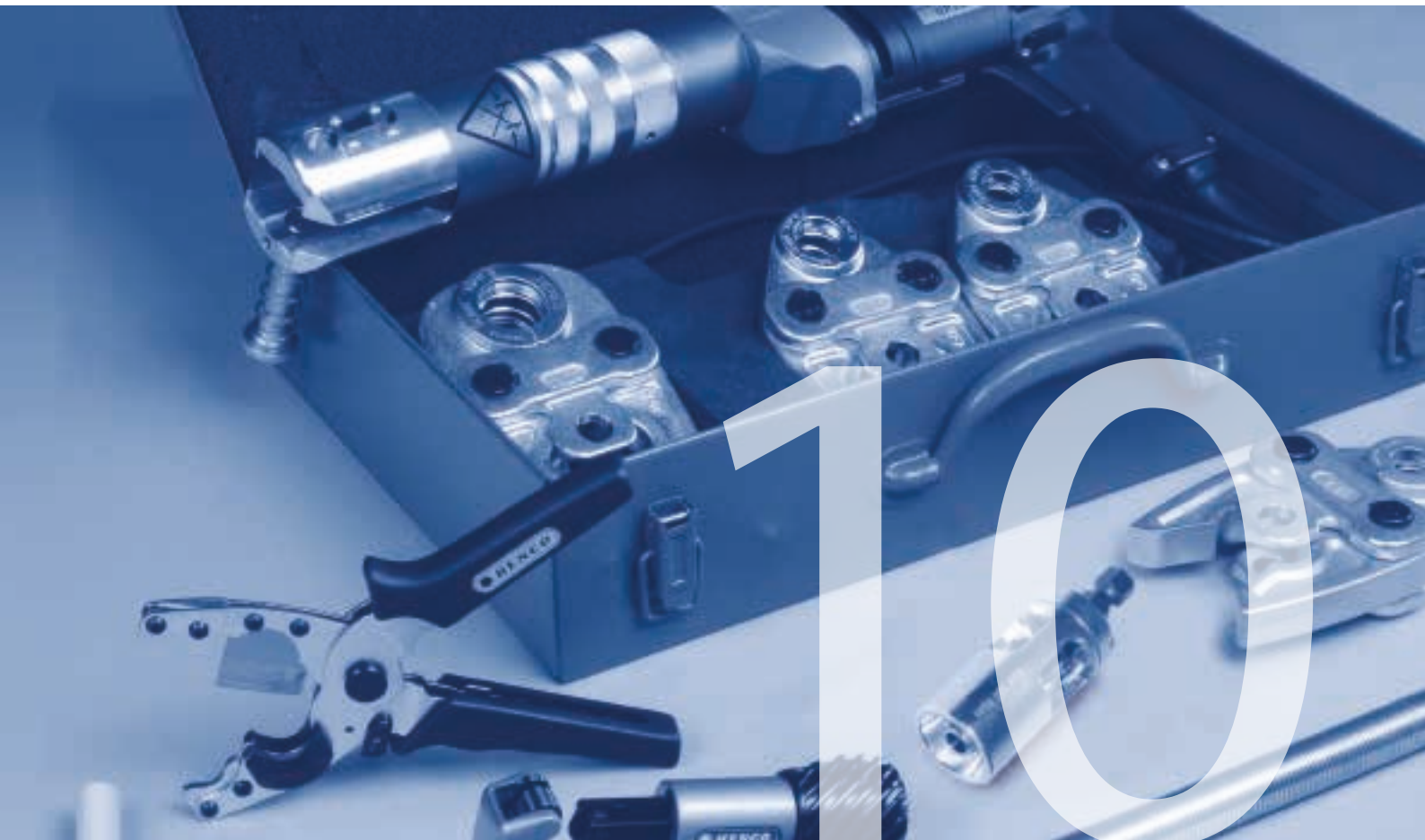

Press machines, press jaws and calibrating tools should be checked on a regular base when used intensively.

Persmachines, persbekken en kalibreergereedschap dienen bij intensief gebruik op regelmatige basis gecontroleerd te worden.

Des machines à sertir, des pinces et des outils pour calibrage soumis à un usage intensif doivent être contrôlé régulièrement.

Press Maschinen, Pressbacken und Kalibrierung Werkzeuge sollten auf einer regelmäßigen Basis überprüft werden, wenn intensiv genutzt.



Type: BI



Internal bending spring
Binnenbuigveer
Ressort à plier intérieur
Biegefeder innen

Article number	pc / Box	Type
BI-1410	1 pc. / 100 pc.	14x2 L=50 cm
BI-1612	1 pc. / 100 pc.	16x2 L=50 cm
BI-1612L	1 pc. / 50 pc.	16x2 L=100 cm
BI-1814	1 pc. / 75 pc.	18x2 L=50 cm
BI-2016	1 pc. / 75 pc.	20x2 L=50 cm
BI-2016L	1 pc. / 25 pc.	20x2 L=100 cm
BI-2620	1 pc. / 25 pc.	26x3 L=100 cm

Type: BA



External bending spring
Buitenbuigveer
Ressort à plier extérieur
Biegefeder aussen

Article number	pc / Box	Type
BA-1288	1 pc. / 50 pc.	12x1,88 L=50 cm
BA-1410	1 pc. / 50 pc.	14x2 L=50 cm
BA-1612	1 pc. / 50 pc.	16x2 L=50 cm
BA-1814	1 pc. / 50 pc.	18x2 L=50 cm
BA-2016	1 pc. / 50 pc.	20x2 L=50 cm

Type: BM



Bending tool
Buigijzer
Cintreuse
Biegewerkzeug

Article number	Packing	Type
BM-16	1 pc.	for Ø16
BM-20	1 pc.	for Ø20
BM-26	1 pc.	for Ø26

Type: RSPRESS



Guillotine cutter
Guillotineschaar
Pince guillotine
Guillotinezange

Article number	Packing	Type
RS1420PRESS	1 pc.	14 till 20 mm
RS2640PRESS	1 pc.	26 till 40 mm

Type: RSEM-PERS



Replacement blade for art. RS1420PRESS and RS2640PRESS

Vervangmes voor art. RS1420PRESS en RS2640PRESS

Lame pour art. RS1420PRESS et RS2640PRESS

Ersatzmesser für Art. RS1420PRESS UND RS2640PRESS

Article number	Packing	Type
RSEM1420-PERS	1 pc.	14 till 20 mm
RSEM2640-PERS	1 pc.	26 till 40 mm

Type: RSPRESS-N



Guillotine cutter

Guillotineschaar

Pince guillotine

Guillotinezange

Article number	Packing	Type
RS1420PRESS-N	1 pc.	14 till 20 mm

Type: RS



Wheel cutter

Buizensnijder

Coupe-tube

Rohrschneidezange

Article number	Packing	Type
RS32	1 pc.	14 till 32 mm
RS63	1 pc.	14 till 63 mm

Type: RSEM



Replacement wheel for art. RS32 and RS63

Vervangmes voor art. RS32 en RS63

Lame de rechange pour art. RS32 et RS63

Ersatzmesser für Art. RS32 und RS63

Article number	Packing	Type
RSEM32	1 pc.	14 till 32 mm
RSEM63	1 pc.	14 till 63 mm



Type: SAFECUT



Cutter to open the packing paper
 Mes om verpakkingspapier te openen
 Couteau pour ouvrir le papier d'emballage
 Schneider zum Öffnen der Packing

Article number	Packing	Type
SAFECUT	1 pc.	SAFECUT

Type: PS-16



Pipe straightener Ø16
 Buizenrechter Ø16
 Redresseur Ø16
 Rohrbegradiger Ø16

Article number	Packing	Type
PS-16	1 pc.	PS

Characteristics PS-16

- ▶ Simplifies installation and reduces labour
- ▶ Easy to use
- ▶ Less material usage and waste
- ▶ Accelerated flow for better efficiencies and reduced running costs
- ▶ Professional looking finish

Type: KS-MSET1



Set with KS-K and KS-M for Ø16, 20 and 26
 Set met KS-K en KS-M voor Ø16, 20 en 26
 Set avec KS-K et KS-M pour Ø16, 20 et 26
 Set mit KS-K und KS-M für Ø16, 20 und 26

Article number	Packing	Type
KS-MSET1	1 pc.	MSET1

Type: KS-MSET4



Set with KS-K and KS-M for Ø16, 20, 26 and 32
 Set met KS-K en KS-M voor Ø16, 20, 26 en 32
 Set avec KS-K et KS-M pour Ø16, 20, 26 et 32
 Set mit KS-K und KS-M für Ø16, 20, 26 und 32

Article number	Packing	Type
■ KS-MSET4	1 pc.	MSET4

Type: KS



Kalispeed for electric drills (max. 500 rpm, clockwise only)
Kalispeed voor accu-boormachine (max. 500 toeren, rechts draaien verplicht)
Kalispeed pour perceuses à batterie (max. 500 tournages, obligation de tourner à droite)
Kalispeed für Akku-Bohrmaschine (max. 500 Drehungen, rechts drehen verpflichtet)

Article number	Packing	Type
KS50	1 pc.	for Ø50
KS63	1 pc.	for Ø63

Type: KS-M



Kalispeed, metal, for KS-K and electric drills (max. 500 rpm, clockwise only)
Kalispeed, metaal, voor KS-K en accu-boormachine (max. 500 toeren, rechts draaien verplicht)
Kalispeed, métal, pour KS-K et perceuses à batterie (max. 500 tours, obligation de tourner à droite)
Kalispeed, Metall, für KS-K und Akku-Bohrmaschine (max. 500 Drehungen, rechts drehen verpflichtet)

Article number	Packing	Type
KS12M	1 pc.	for Ø12
KS14M	1 pc.	for Ø14
KS16M	1 pc.	for Ø16
KS18M	1 pc.	for Ø18
KS20M	1 pc.	for Ø20
KS26M	1 pc.	for Ø26
KS32M	1 pc.	for Ø32
KS40M	1 pc.	for Ø40

Type: KS-K



Clickhandle for KS (Kalispeed)
Klikhandvat voor KS (Kalispeed)
Manche clic pour KS (Kalispeed)
Klickgriff für KS (Kalispeed)

Article number	Packing	Type
KS-K	1 pc.	up to Ø26 mm

Type: KS-P



Kalispeed for Ø16, 20 and 26
Kalispeed voor Ø16, 20 en 26
Kalispeed pour Ø16, 20 et 26
Kalispeed für Ø16, 20 und 26

Article number	Packing	Type
KS-P162026	1 pc.	for Ø16, 20 and 26

Not for intensive use



Type: PH-1632



Pipe holder for diameters 16-20-26-32
 Griptang voor buis diameter 16-20-26-32
 Pince de maintien diamètre 16-20-26-32
 Rohrhalter für Diameter 16-20-26-32

Article number	Packing	Type
PH-1632	1 pc.	up to 32 mm

Characteristics PH-1632

- ▶ Always sufficient grip when calibrating short pipe ends
- ▶ Prevents the pipe from turning too during calibration
- ▶ Inspired by the classic nutcracker model
- ▶ Henco blue anodised aluminium
- ▶ Lightweight tool
- ▶ Suitable for pipe diameters of 16 –20 –26 –32



Type: M-BA03



Kit: battery press machine including battery + charge unit + case, linear drive 32 kN, up to Ø 63
 Kit: accu-persmachine + accu + lader + koffer, lineaire aandrijving 32 kN, tot Ø 63
 Kit: machine à sertir + batterie + chargeur + coffret, propulsion linéaire 32 kN, jusqu'à Ø 63
 Kit: Akku-Pressmaschine, lineare Schubkraft 32 kN, bis Ø 63

Article number	Packing	Type
M-BA03	1 pc.	BA03

Type: M-BAT03



Battery for M-BA03
 Accu voor M-BA03
 Batterie pour M-BA03
 Akku für M-BA03

Article number	Packing	Type
M-BAT03	1 pc.	BAT03



Type: M-LAD03



Charge-unit for M-BA03, M-BMINI2
 Lader voor M-BA03, M-BMINI2
 Chargeur pour M-BA03, M-BMINI2
 Akku-Ladegerät für M-BA03, M-BMINI2

Article number	Packing	Type
M-LAD03	1 pc.	LAD03

Type: M-TRANS03



Mains Adapter for M-BA03
 Adapter voor netaansluiting voor M-BA03
 Adapteur raccordement au réseau pour M-BA03
 Netzadapter für M-BA03I

Article number	Packing	Type
M-TRANS03	1 pc.	TRANS03

Type: M-BOXBA03

Case for M-BA03
 Koffer voor M-BA03
 Coffret pour M-BA03
 Koffer für M-BA03

Article number	Packing	Type
M-BOXBA03	1 pc.	CASE M-BA03

Type: M-BAT



Battery for M-BA00
 Accu voor M-BA00
 Batterie pour M-BA00
 Akku für M-BA00

Article number	Packing	Type
M-BAT	1 pc.	BAT

Type: M-LAD



Charge-unit for M-BA00 and M-BMINI
 Lader voor M-BA00 en M-BMINI
 Chargeur pour M-BA00 et M-BMINI
 Akku-Ladegerät für M-BA00 und M-BMINI

Article number	Packing	Type
M-LAD	1 pc.	LAD

- 1
- 2
- 3
- 4
- 5
- 6
- 7
- 8
- 9
- 10
- 11



Type: M-TRANS



Mains Adapter for M-BA00 (cord length: 4m)
Adapter voor netaansluiting M-BA00 (snoer: 4m)
Adapteur raccordement au réseau M-BA00 (câble: 4m)
Netzadapter für M-BA00 (Kabellänge:4m)

Article number	Packing	Type
M-TRANS	1 pc.	TRANS

TILL EXHAUSTION OF STOCK

Type: M-BHY162026



Kit : 230 volt hydraulic press machine with 16, 20, 26 jaws + metal case (110 volt also available), linear drive 32 to 40 kN
Kit : Elektrisch-hydraulische persmachine + bekken 16, 20, 26 + koffer, lineaire aandrijving 32 tot 40kN
Kit : machine à sertir électro-hydraulique + pinces 16, 20, 26 + coffret, propulsion linéaire 32 jusqu'à 40 kN
Kit : Elektrohydraulische Pressmaschine + Pressbacken 16, 20, 26 + Koffer, lineare Schubkraft 32 bis 40 kN

Article number	Packing	Type
M-BHY162026	1 pc.	Ø14-63

Type: M-BHY



Kit : 230 volt hydraulic press machine + metal case (110 volt also available), linear drive 32 to 40 kN
Kit : Elektrisch-hydraulische persmachine + koffer, lineaire aandrijving 32 tot 40kN
Kit : machine à sertir électro-hydraulique + coffret, propulsion linéaire 32 jusqu'à 40 kN
Kit : Elektrohydraulische Pressmaschine + Koffer, lineare Schubkraft 32 bis 40 kN

Article number	Packing	Type
M-BHY	1 pc.	Ø14-63

Type: M-BOXBHY



Metal case for M-BHY162026
Koffer voor M-BHY162026
Coffret en métal pour M-BHY162026
Koffer für M-BHY162026

Article number	Packing	Type
M-BOXBHY	1 pc.	Ø14-63

Type: BE



Jaws (universal)
Persbekken (universeel)
Pincas à sertir (universel)
Pressbacken (universal)

Article number	Packing	Type
BE14	1 pc.	BE/TH 14x2
BE16	1 pc.	BE/TH 16x2
BE18	1 pc.	BE/TH 18x2
BE20	1 pc.	BE/TH 20x2
BE26	1 pc.	BE/TH 26x3
BE32	1 pc.	BE 32x3
BE40	1 pc.	BE 40x3,5
BE50	1 pc.	BE 50x4
BE63	1 pc.	BE 63x4,5

Type: BE-UNISET1



Set with universal jaw mounting unit and BE-H inserts Ø16, 20 and 26
Set met universele moederbekken wisselbekken BE-H Ø16, 20, 26
Set avec pince mère universel et pinces BE-H Ø16, 20, 26
Set mit Mutterpressbacke universal und Backen BE-H Ø16, 20, 26

Article number	Packing	Type
BE-UNISET1	1 pc.	UNISET1

Press tool compatibility: see technical manual

Type: BE-UNISET2



Set with universal jaw mounting unit and BE-H inserts Ø14, 16, 18, 20, 26, and 32
Set met universele moederbek en wisselbekken BE-H Ø14, 16, 18, 20, 26 en 32
Set avec pince mère universel et pinces BE-H Ø14, 16, 18, 20, 26, et 32
Set mit Mutterpressbacke universal und Backen BE-H Ø14, 16, 18, 20, 26, und 32

Article number	Packing	Type
BE-UNISET2	1 pc.	UNISET2

Press tool compatibility: see technical manual



Type: TOOLBOX16202632



Box with KS16 20 26 32 M, BE-UNI, BE16 20 26 32 H, BI-1612, BI-2016, BA-1612, BA-2016, RS1420PRESS, SAFECUT
 Koffer met KS16 20 26 32 M, BE-UNI, BE16 20 26 32 H, BI-1612, BI-2016, BA-1612, BA-2016, RS1420PRESS, SAFECUT
 Coffre avec KS16 20 26 32 M, BE-UNI, BE16 20 26 32 H, BI-1612, BI-2016, BA-1612, BA-2016, RS1420PRESS, SAFECUT
 Koffer mit KS16 20 26 32 M, BE-UNI, BE16 20 26 32 H, BI-1612, BI-2016, BA-1612, BA-2016, RS1420PRESS, SAFECUT

Article number	Packing	Type
TOOLBOX16202632	1 pc.	TOOLBOX16202632

Type: TOOLBOX405063



Box with KS40M, KS50, KS63, BE40 50 63, RS63
 Koffer met KS40M, KS50, KS63, BE40 50 63, RS63
 Coffre avec KS40M, KS50, KS63, BE40 50 63, RS63
 Koffer mit KS40M, KS50, KS63, BE40 50 63, RS63

Article number	Packing	Type
TOOLBOX405063	1 pc.	TOOLBOX405063

Type: BE-UNI



Jaw mounting unit for M-BA03 and M-BHY, to be used with BE-H jaws
 Moederbek voor M-BA03 en M-BHY en te gebruiken met BE-H bekken
 Pince mère pour M-BA03 et M-BHY, à utiliser avec pinces BE-H
 Mutterpressbacke für M-BA003 und M-BHY, zu verwenden mit BE-H Backen

Article number	Packing	Type
BE-UNI	1 pc.	BE-UNI

Press tool compatibility: see technical manual

BE-UNI is designed to press Henco press fittings, the interchangeable dies with M- and V-profile make it possible to make the transition from other materials to Henco; other than Henco branded fittings with compact measurements can cause complex manipulation.

Type: BE-H



Inserts for BE-UNI, BE-MINI2, BE-MINI3, M-BH

Wisselbekken voor BE-UNI, BE-MINI2, BE-MINI3, M-BH

Pinces pour BE-UNI, BE-MINI2, BE-MINI3, M-BH

Pressbacken für BE-UNI, BE-MINI2, BE-MINI3, M-BH

Article number	Packing	Type
BE14H	1 Set (2 pc.)	BE/TH 14X2 H
BE16H	1 Set (2 pc.)	BE/TH 16X2 H
BE18H	1 Set (2 pc.)	BE/TH 18X2 H
BE20H	1 Set (2 pc.)	BE/TH 20X2 H
BE26H	1 Set (2 pc.)	BE/TH 26X3 H
BE32H	1 Set (2 pc.)	BE 32X3 H

Type: BE-HC



Inserts (copper) for BE-UNI, BE-MINI2, M-BH

Wisselbekken (koper) voor BE-UNI, BE-MINI2, M-BH

Pinces (cuivre) pour BE-UNI, BE-MINI2, M-BH

Pressbacken (Kupfer) für BE-UNI, BE-MINI2, M-BH

Article number	Packing	Type
BE12HC	1 Set (2 pc.)	12Cu V-profile
BE14HC	1 Set (2 pc.)	14Cu V-profile
BE15HC	1 Set (2 pc.)	15Cu V-profile
BE16HC	1 Set (2 pc.)	16Cu V-profile
BE18HC	1 Set (2 pc.)	18Cu V-profile
BE22HC	1 Set (2 pc.)	22Cu V-profile
BE28HC	1 Set (2 pc.)	28Cu V-profile

Type: BE-HM



Inserts (copper) for BE-UNI, BE-MINI2, M-BH

Wisselbekken (koper) voor BE-UNI, BE-MINI2, M-BH

Pinces (cuivre) pour BE-UNI, BE-MINI2, M-BH

Pressbacken (Kupfer) für BE-UNI, BE-MINI2, M-BH

Article number	Packing	Type
BE12HM	1 Set (2 pc.)	12Cu M-profile
BE15HM	1 Set (2 pc.)	15Cu M-profile
BE18HM	1 Set (2 pc.)	18Cu M-profile
BE22HM	1 Set (2 pc.)	22Cu M-profile

Type: BE-BOX



Metal case for 4 compression jaws

Stalen koffer voor 4 persbekken

Coffret en métal pour 4 pinces à sertir

Stahlblechkasten für 4 Pressbacken

Article number	Packing	Type
BE-BOX	1 pc.	BOX



Type: M-BMINI3-F



Kit : compact rechargeable battery press machine with press monitoring + case + charge unit + battery 18V + full jaws TH16-20-26, linear drive ca. 19 kN

Kit: hydraulische accu-persmachine met persbewaking + koffer + lader + 1 accu 18V + volle bekken TH16-20-26, lineaire aandrijving ca. 19kN

Kit : machine à sertir hydraulique + boîte + chargeur + batterie 18V, pince TH16-20-26, propulsion linéaire ca.19 kN

Kit: Hydraulisches Akku-Presswerkzeug mit Pressdrucküberwachung + Koffer + Ladegerät + 1 Akku 18V + Pressbacken TH16-20-26, lineare Schubkraft ca. 19 kN

Article number	Packing	Type
M-BMINI3-F	1 pc.	Ø16-26 / 18V

Type: M-BMINI3



Kit : compact rechargeable battery press machine with press monitoring + case + charge unit + battery 18V + mother jaw + inserts TH16-20-26, linear drive ca. 19 kN

Kit: hydraulische accu-persmachine met persbewaking + koffer + lader + 1 accu 18V + moederbek met inserts TH16-20-26, lineaire aandrijving ca. 19kN

Kit : machine à sertir hydraulique + boîte + chargeur + batterie 18V + pince mère + inserts TH16-20-26, propulsion linéaire ca.19 kN

Kit: Hydraulisches Akku-Presswerkzeug mit Pressdrucküberwachung + Koffer + Ladegerät + 1 Akku 18V + Mutterpressbacke und Pressbacken TH16-20-26, lineare Schubkraft ca. 19 kN

Article number	Packing	Type
M-BMINI3	1 pc.	Ø16-26 / 18V

Type: M-BMINI3-S



Kit : compact rechargeable battery press machine with press monitoring + case + charge unit + battery 18V, linear drive ca. 19 kN

Kit: hydraulische accu-persmachine met persbewaking + koffer + lader + 1 accu 18V, lineaire aandrijving ca. 19kN

Kit : machine à sertir hydraulique + boîte + chargeur + batterie 18V, propulsion linéaire ca.19 kN

Kit: Hydraulisches Akku-Presswerkzeug mit Pressdrucküberwachung + Koffer + Ladegerät + 1 Akku 18V, lineare Schubkraft ca. 19 kN

Article number	Packing	Type
M-BMINI3-S	1 pc.	Ø16-26 / 18V

Type: M-BATMINI3



Battery 18V for M-BMINI3-F, M-BMINI3, M-BMINI3-S
Accu 18V voor M-BMINI3-F, M-BMINI3, M-BMINI3-S
Batterie 18V pour M-BMINI3-F, M-BMINI3, M-BMINI3-S
Akku 18V für M-BMINI3-F, M-BMINI3, M-BMINI3-S

Article number	Packing	Typ
■ M-BATMINI3-1.5AH	1 pc.	18V / 1,5 Ah Li-ion
■ M-BATMINI3-3.0AH	1 pc.	18V / 3,0 Ah Li-ion

Type: M-LADMINI3



Charge-unit for M-BMINI3-F, M-BMINI3, M-BMINI3-S
Lader voor M-BMINI3-F, M-BMINI3, M-BMINI3-S
Chargeur pour M-BMINI3-F, M-BMINI3, M-BMINI3-S
Akku-Ladegerät für M-BMINI3-F, M-BMINI3, M-BMINI3-S

Article number	Packing	Type
■ M-LADMINI3	1 pc.	for M-BATMINI3

Type: M-TRANSMINI3



Mains Adapter for M-BMINI3-F, M-BMINI3, M-BMINI3-S + 5m cable
Adapter voor netaansluiting M-BMINI3-F, M-BMINI3, M-BMINI3-S + 5m kabel
Adaptateur raccordement au réseau M-BMINI3-F, M-BMINI3, M-BMINI3-S + 5m cable
Netzadapter für M-BMINI3-F, M-BMINI3, M-BMINI3-S + 5m Kabel

Article number	Packing	Type
■ M-TRANSMINI3	1 pc.	18V / 230V

Type: M-BOXMINI3



Metal case for M-BMINI3, M-BMINI3-S
Koffer in metaal voor M-BMINI3, M-BMINI3-S
Coffret en métal pour M-BMINI3, M-BMINI3-S
Koffer in Metal für M-BMINI3, M-BMINI3-S

Article number	Packing	Type
■ M-BOXMINI3	1 pc.	M-BOXMINI3



Type: M-BOXMINI3-F



Metal case for M-BMINI3-F
 Koffer in metaal voor M-BMINI3-F
 Coffret en métal pour M-BMINI3-F
 Koffer in Metal für M-BMINI3-F

Article number	Packing	Type
■ M-BOXMINI3-F	1 pc.	M-BOXMINI3-F

Type: BE-MINI3



Mother jaw press machine M-BMINI3 with BE-H inserts
 Moederbek voor persmachine M-BMINI3 met BE-H inserts
 Pince mère pour machine à sertir M-BMINI3 avec pinces BE-H
 Mutterpressbacke für Presswerkzeuge M-BMINI3, zu verwenden mit BE-H backen

Article number	Packing	Type
■ BE-MINI3	1 pc.	BE-MINI3

Type: BE..-MINI3



Jaw for press machine M-BMINI3 - TH profile
 Bek voor persmachine M-BMINI3 - TH profiel
 Pince pour machine à sertir M-BMINI3 - Profil TH
 Pressbacke für Presswerkzeuge M-BMINI3 + Profil TH

Article number	Packing	Type
■ BE16MINI3	1 pc.	BE/TH Ø16
■ BE20MINI3	1 pc.	BE/TH Ø20
■ BE26MINI3	1 pc.	BE/TH Ø26
■ BE32MINI3	1 pc.	BE Ø32

Type: BE.V-MINI3



Jaw for press machine M-BMINI3 - V profile
 Bek voor persmachine M-BMINI3 - V profiel
 Pince pour machine à sertir M-BMINI3 - Profil V
 Pressbacke für Presswerkzeuge M-BMINI3 + Profil V

Article number	Packing	Type
■ BE15V-MINI3	1 pc.	V-profile 15mm
■ BE18V-MINI3	1 pc.	V-profile 18mm
■ BE22V-MINI3	1 pc.	V-profile 22mm
■ BE28V-MINI3	1 pc.	V-profile 28mm

Type: M-BMINI2-SLB



Kit : compact rechargeable battery press machine with press monitoring + case, linear drive ca. 15 kN

Kit: hydraulische accu-persmachine met persbewaking + kunststofkoffer, lineaire aandrijving ca. 15kN

Kit : machine à sertir hydraulique + boîte en plastique, propulsion linéaire ca.15 kN

Kit: Hydraulisches Akku-Presswerkzeug mit Pressdrucküberwachung + Kunststoffkoffer, lineare Schubkraft ca. 15 kN

Article number	Packing	Type
M-BMINI2-SLB	1 pc.	Ø14-32, 18V / 1,5 Ah Li-ion

Type: M-BATMINI2



Battery 18V / 1,5 Ah Li-ion for M-BMINI2

Accu 18V / 1,5 Ah Li-ion voor M-BMINI2

Batterie 18V / 1,5 Ah Li-ion pour M-BMINI2

Akku 18V / 1,5 Ah Li-ion für M-BMINI2

Article number	Packing	Typ
M-BATMINI2	1 pc.	18V / 1,5 Ah Li-ion

Type: M-TRANSMINI2



Mains Adapter for M-BMINI2(S)

Adapter voor netaansluiting M-BMINI2(-S)

Adapteur raccordement au réseau M-BMINI2(-S)

Netzadapter für M-BMINI2(-S)

Article number	Packing	Type
M-TRANSMINI2	1 pc.	18V / 230V



- 1
- 2
- 3
- 4
- 5
- 6
- 7
- 8
- 9
- 10
- 11

Type: M-BOXMINI2



Case for M-BMINI2(-S)
 Koffer voor M-BMINI2(-S)
 Coffret pour M-BMINI2(-S)
 Koffer für M-BMINI2(-S)

Article number	Packing	Type
M-BOXMINI2	1 pc.	M-BOXMINI2

Type: M-BATMINI



Battery 9,6V / 2,0 Ah for M-BMINI
 Accu 9,6V / 2,0 Ah voor M-BMINI
 Batterie 9,6V / 2,0 Ah pour M-BMINI
 Akku 9,6V / 2,0 Ah für M-BMINI

Article number	Packing	Type
M-BATMINI	1 pc.	9,6V / 2,0 Ah

Type: BE..-MINI



Jaw for press machine M-BMINI2(-S) and M-HP32
 Bek voor persmachine M-BMINI2(-S) en M-HP32
 Pince pour machine à sertir M-BMINI2(-S) et M-HP32
 Pressbacke für Presswerkzeuge M-BMINI2(-S) und M-HP32

Article number	Packing	Type
BE16MINI	1 pc.	BE/TH Ø16
BE20MINI	1 pc.	BE/TH Ø20
BE26MINI	1 pc.	BE/TH Ø26
BE32MINI	1 pc.	BE Ø32

Type: BE..-MMINI



M-profile jaw (copper) for press machine M-BMINI2(-S) and M-HP32
 M-profiel bek (koper) voor persmachine M-BMINI2(-S) en M-HP32
 M-profil pince (cuivre) pour machine à sertir M-BMINI2(-S) et M-HP32
 M-profil Pressbacke (Kupfer) für Presswerkzeuge M-BMINI2(-S) und M-HP32

Article number	Packing	Type
BE15MMINI	1 pc.	Ø15Cu M-Profile
BE22MMINI	1 pc.	Ø22Cu M-Profile

Type: BE-C



V-profile jaw (copper) for press machine M-BMINI2(-S) and M-HP32
V-profiel bek (koper) voor persmachine M-BMINI2(-S) en M-HP32
V-profil pinces (cuivre) pour machine à sertir M-BMINI2(-S) et M-HP32
V-profil Pressbacke (Kupfer) für Presswerkzeuge M-BMINI2(-S) und M-HP32

Article number	Packing	Type
BE15C	1 pc.	Ø15Cu V-Profile
BE18C	1 pc.	Ø18Cu V-Profile
BE22C	1 pc.	Ø22Cu V-Profile
BE28C	1 pc.	Ø28Cu V-Profile

Type: BE-MINI



Jaw mounting unit for press machine M-BMINI2(-S) / M-HP32 and to be used with BE-H jaws
Moederbek voor persmachine M-BMINI2(-S) / M-HP32 en te gebruiken met BE-H bekken
Pince mère pour machine à sertir M-BMINI2(-S) / M-HP32 et à utiliser avec pinces BE-H
Mutterpressbacke für Presswerkzeug M-BMINI2(-S) / M-HP32, zu verwenden mit BE-H Backen

Article number	Packing	Type
BE-MINI	1 pc.	BE-MINI

BE-MINI is designed to press Henco press fittings, the interchangeable dies with M- and V-profile make it possible to make the transition from other materials to Henco; other than Henco branded fittings with compact measurements can cause complex manipulation

Type: BE-H



Inserts for BE-UNI, BE-MINI2, BE-MINI3, M-BH
Wisselbekken voor BE-UNI, BE-MINI2, BE-MINI3, M-BH
Pinces pour BE-UNI, BE-MINI2, BE-MINI3, M-BH
Pressbacken für BE-UNI, BE-MINI2, BE-MINI3, M-BH

Article number	Packing	Type
BE14H	1 Set (2 pc.)	BE/TH 14X2 H
BE16H	1 Set (2 pc.)	BE/TH 16X2 H
BE18H	1 Set (2 pc.)	BE/TH 18X2 H
BE20H	1 Set (2 pc.)	BE/TH 20X2 H
BE26H	1 Set (2 pc.)	BE/TH 26X3 H
BE32H	1 Set (2 pc.)	BE 32X3 H



Type: BE-HC



Inserts (copper) for BE-UNI, BE-MINI2, M-BH
 Wisselbekken (koper) voor BE-UNI, BE-MINI2, M-BH
 Pincas (cuivre) pour BE-UNI, BE-MINI2, M-BH
 Pressbacken (Kupfer) für BE-UNI, BE-MINI2, M-BH

Article number	Packing	Type
BE12HC	1 Set (2 pc.)	12Cu V-profile
BE14HC	1 Set (2 pc.)	14Cu V-profile
BE15HC	1 Set (2 pc.)	15Cu V-profile
BE16HC	1 Set (2 pc.)	16Cu V-profile
BE18HC	1 Set (2 pc.)	18Cu V-profile
BE22HC	1 Set (2 pc.)	22Cu V-profile
BE28HC	1 Set (2 pc.)	28Cu V-profile

Type: BE-HM



Inserts (copper) for BE-UNI, BE-MINI2, M-BH
 Wisselbekken (koper) voor BE-UNI, BE-MINI2, M-BH
 Pincas (cuivre) pour BE-UNI, BE-MINI2, M-BH
 Pressbacken (Kupfer) für BE-UNI, BE-MINI2, M-BH

Article number	Packing	Type
BE12HM	1 Set (2 pc.)	12Cu M-profile
BE15HM	1 Set (2 pc.)	15Cu M-profile
BE18HM	1 Set (2 pc.)	18Cu M-profile
BE22HM	1 Set (2 pc.)	22Cu M-profile

Type: M-HP



Hydraulic manual press tool + bag
 Hydraulisch handpersmachine + draagtas
 Machine à sertir manuelle hydraulique + sac
 Hydraulisches Handpressmaschine + Tasche

Article number	pc	Type
M-HP32	1 pc.	Ø14-32

Type: M-BH



Kit: manual press machine + inserts 16,20,26 + bag
 Kit: handpersmachine + bken 16, 20, 26 + draagtas
 Kit: machine à sertir manuelle + pinces 16, 20, 26 + sac
 Kit: Handpersmaschine + Pressbacken 16, 20, 26 + Tasche

Article number	Packing	Type
M-BH162026	1 pc.	BH 16x2 / 20x2 / 26x3

Type: BE-H



Inserts for BE-UNI, BE-MINI2, BE-MINI3, M-BH
Wisselbekken voor BE-UNI, BE-MINI2, BE-MINI3, M-BH
Pinces pour BE-UNI, BE-MINI2, BE-MINI3, M-BH
Pressbacken für BE-UNI, BE-MINI2, BE-MINI3, M-BH

Article number	Packing	Type
BE14H	1 Set (2 pc.)	BE/TH 14X2 H
BE16H	1 Set (2 pc.)	BE/TH 16X2 H
BE18H	1 Set (2 pc.)	BE/TH 18X2 H
BE20H	1 Set (2 pc.)	BE/TH 20X2 H
BE26H	1 Set (2 pc.)	BE/TH 26X3 H
BE32H	1 Set (2 pc.)	BE 32X3 H

Type: BE-HC



Inserts (copper) for BE-UNI, BE-MINI2, M-BH
Wisselbekken (koper) voor BE-UNI, BE-MINI2, M-BH
Pinces (cuivre) pour BE-UNI, BE-MINI2, M-BH
Pressbacken (Kupfer) für BE-UNI, BE-MINI2, M-BH

Article number	Packing	Type
BE12HC	1 Set (2 pc.)	12Cu V-profile
BE14HC	1 Set (2 pc.)	14Cu V-profile
BE15HC	1 Set (2 pc.)	15Cu V-profile
BE16HC	1 Set (2 pc.)	16Cu V-profile
BE18HC	1 Set (2 pc.)	18Cu V-profile
BE22HC	1 Set (2 pc.)	22Cu V-profile
BE28HC	1 Set (2 pc.)	28Cu V-profile

Type: BE-HM



Inserts (copper) for BE-UNI, BE-MINI2, M-BH
Wisselbekken (koper) voor BE-UNI, BE-MINI2, M-BH
Pinces (cuivre) pour BE-UNI, BE-MINI2, M-BH
Pressbacken (Kupfer) für BE-UNI, BE-MINI2, M-BH

Article number	Packing	Type
BE12HM	1 Set (2 pc.)	12Cu M-profile
BE15HM	1 Set (2 pc.)	15Cu M-profile
BE18HM	1 Set (2 pc.)	18Cu M-profile
BE22HM	1 Set (2 pc.)	22Cu M-profile

Type: M-BM1620



Kit: manual press machine with 16, 20 jaws
Kit: handpersmachine + wisselbekken 16, 20
Kit: machine à sertir manuelle + pinces 16, 20
Kit: Handpressmaschine + Pressbacken 16, 20

Article number	Packing	Type
M-BM1620	1 pc.	BM 16x2 / 20x2



Type: BE-M



Inserts for M-BM1620
Wisselbekken voor M-BM1620
Pinces pour M-BM1620
Pressbacken für M-BM1620

Article number	Packing	Type
BE14M	1 Set (2 pc.)	BE 14X2 M
BE16M	1 Set (2 pc.)	BE 16X2 M
BE18M	1 Set (2 pc.)	BE 18X2 M
BE20M	1 Set (2 pc.)	BE 20X2 M

Type: PRESSCHECK



Tool to control the accuracy of a pressing
Instrument om correctheid v/e persing te controleren
Outil pour contrôler la précision d'un sertissage
Instrument zur Überprüfung ob die Pressung korrekt ausgeführt

Article number	Packing	Type
PRESSCHECK1432	1 pc.	Ø14-32

Type: DRILLY



Drilly temporary air vent plug, reusable
Drilly voor afdrukken leidingssysteem, herbruikbaar
Drilly pour tester le système de tubes, réutilisable
Drilly zum abdrukken Rohrsysteme, wieder verwendbar

Article number	Packing	Type
DRILLY14	1 pc.	Ø14
DRILLY16	1 pc.	Ø16
DRILLY18	1 pc.	Ø18
DRILLY20	1 pc.	Ø20
DRILLY26	1 pc.	Ø26
DRILLY32	1 pc.	Ø32

Type: PLUG



Plug
Afdrukplug
Bouchon
Stopf

Article number	Tasche	Type
PLUG04-B80	20 pc.	1/2" - 80 mm blue
PLUG04-R80	20 pc.	1/2" - 80 mm red
PLUG05-B80	20 pc.	3/4" - 80 mm blue
PLUG05-R80	20 pc.	3/4" - 80 mm red



Type: UFH-VLA



Decoiler, standard model
 Haspel, basismodel
 Machine à dérouler, standard
 Abwickelmaschine, Standard

Article number	Packing	Type
UFH-VLA	1 pc.	25 m - 600 m

Minimum inner diameter coil: 140mm

Type: UFH-VLA-STR



Pipe straightener for decoiler UFH-VLA 14-26 mm
 Stangenrechter voor haspel UFH-VLA 14-26 mm
 Machine à produire des barres pour dérouleur UFH-VLA 14-26 mm
 Stangenmaschine für Wickelmaschine UFH-VLA 14-26 mm

Article number	Packing	Type
UFH-VLA-STR	1 pc.	

Type: UFH-VLG



Decoiler, tilting possible, on wheels
 Haspel, kantelbaar, op wielen
 Machine à dérouler, mobile et basculable
 Abwickelmaschine, mobil, drehbar

Article number	Packing	Type
UFH-VLG	1 pc.	25 m - 600 m

TILL EXHAUSTION OF STOCK

Type: UFH-RAS-VLE



Braid hook
 Vlechthaak
 Crochet de tressage
 Gerät zum Flechten von Stahldraht

Article number	Packing	Type
UFH-RAS-VLE	1 pc.	

Type: UFH-RAS-CUT



Cutter for steel mesh
 Kniptang voor stalen draadmatten
 Pince coupante pour treillis
 Schere für Trägermatte

Article number	Packing	Type
UFH-RAS-CUT	1 pc.	

- 1
- 2
- 3
- 4
- 5
- 6
- 7
- 8
- 9
- 10
- 11



Type: HNTOOLSET



Toolset for the Super Size range
 Toolset voor het Super Size gamma
 Toolset pour la gamme Super Size
 Toolset für das Super Size Angebot

Article number	pc	Type
HNTOOLSET	1 pc.	Super Size

Type: PK-TOOL



Wrench for PK/SK fittings with threading
 Sleutel voor PK/SK fittings met draad
 Clé pour raccords PK/SK filetage
 Schlüssel für PK/SK Fittings mit Draht

Article number	Packing	Type
PK-TOOL04	1 pc.	1/2"
PK-TOOL05	1 pc.	3/4"
PK-TOOL06	1 pc.	1"

Type: PK-TOOLBOX040506



Set wrenches for PK/SK fittings 1/2" - 1" threading
 Set sleutels voor PK/SK fittings 1/2" tot 1" draad
 Set clés pour raccords PK/SK filetage 1/2" - 1"
 Set Schlüssel für PK/SK Fittings 1/2" bis 1" Draht

Article number	Packing	Type
PK-TOOL- BOX040506	1 pc.	

Type: PK-TOOLBOX



Empty plastic case for PK-TOOL04/05/06
 Lege koffer voor PK-TOOL04/05/06
 Coffret pour PK-TOOL04/05/06
 Koffer für PK-TOOLBOX04/05/06

Article number	pc	Type
PK-TOOLBOX	1 pc.	

Characteristics PK-TOOL

- ▶ Light weight ratchet key
- ▶ Full grip around fitting profile
- ▶ Plastic body stays intact, even when applying extreme torque
- ▶ Key works as well in clock- as counterclockwise direction
- ▶ Maximum torque transition
- ▶ Size indication on handle
- ▶ Chromed handle
- ▶ Key gripping jaws in anodized aluminum
- ▶ Possibility to grip around mounted fittings due to specific closing mechanism







Type: BCLIP



Clip-it clip for Henco pipes, single
Clip-it beugel voor Henco buizen, enkel
Clip-it attache de fixation pour tubes henco, simple
Clip-it Bügel für Henco Rohre, einfach

Article number	Box	Type
BCLIP-14 *	100 pc.	Ø14
BCLIP-16	100 pc.	Ø16
BCLIP-1820	100 pc.	Ø18 - 20
BCLIP-26	100 pc.	Ø26
BCLIP-32 *	100 pc.	Ø32
BCLIP-40 *	100 pc.	Ø40
BCLIP-50 *	50 pc.	Ø50

** TILL EXHAUSTION OF STOCK*

Type: JCLIP



J-clip pipe clips, single
J-clip beugels, enkel
Attaches de fixation J-clip, simple
J-clip Haken, einfach

Article number	Box	Type
JCLIP-1632	200 pc.	Ø16-32, 70 mm

Type: JCLIP L



J-clip pipe clips, single
J-clip beugels, enkel
Attaches de fixation J-clip, simple
J-clip Haken, einfach

Article number	Box	Type
JCLIP-1632L	200 pc.	Ø16-32, 97 mm

Type: JCLIP DOUBLE



J-clip pipe clips, double
J-clip beugels, dubbel
Attaches de fixation J-clip, double
J-clip Haken, doppelt

Article number	Box	Type
JCLIP-1632D	200 pc.	Ø16-32, 70 mm



Type: JCLIP DOUBLE L



J-clip pipe clips, double
 J-clip beugels, dubbel
 Attaches de fixation J-clip, double
 J-clip Haken, doppelt

Article number	Box	Type
JCLIP-1632DL	200 pc.	Ø16-32, 97 mm

Type: NCLIP



N-clip pipe clips, single
 N-clip beugels, enkel
 Attaches de fixation N-clip, simple
 N-clip Haken, einfach

Article number	Box	Type
NCLIP-1618	500 pc.	Ø16-18, 55 mm
NCLIP-20	250 pc.	Ø20 + Ø14, 16, 18 with protection hose
NCLIP-26	250 pc.	Ø26, 55 mm

TILL EXHAUSTION OF STOCK

Type: NCLIP DOUBLE



N-clip pipe clips, double
 N-clip beugels, dubbel
 Attaches de fixation N-clip, double
 N-clip Haken, doppelt

Article number	Box	Type
NCLIP-20 DOUBLE	250 pc.	Ø20 + Ø14, 16, 18 with protection hose

TILL EXHAUSTION OF STOCK

Type: PIPEPLUG



Protection cap for pipe
 Beschermstopje voor buis
 Capuchon de protection pour tube
 Schutzkappe für Rohr

Article number	Bag / Box	Type
PIPEPLUG16	100 pc. / 700 pc.	Ø 16

- 1
- 2
- 3
- 4
- 5
- 6
- 7
- 8
- 9
- 10
- 11



- 1
- 2
- 3
- 4
- 5
- 6
- 7
- 8
- 9
- 10
- 11

Type: PLP-P-PK



Galvanised bracket for backplate elbow
 Gebogen tappuntbeugel gegalvaniseerd
 Support galvanisé pour culasse sanitaire
 Halteplatte galvanisiert

Article number	Bag / Box	Type
PLP-P-PK	1 pc. / 30 pc.	

Interaxis 153mm

Type: PLF-P-PK



Galvanised bracket flat for backplate elbow
 Vlakke tappuntbeugel gegalvaniseerd
 Support galvanisé pour culasse sanitaire
 Halteplatte flach galvanisiert

Article number	Bag / Box	Type
PLF-P-PK	1 pc. / 80 pc.	

Interaxis 120mm and 153mm

Type: TESTPLUG



Test cap for pipe
 Afdicht/test stopje voor buis
 Capuchon de test pour tube
 Testkappe für Rohr

Article number	Bag / Box	Type
■ TESTPLUG16	20 pc. / 4000 pc.	
■ TESTPLUG20	20 pc. / 2000 pc.	

Type: AK-EK



Adapter from EK 3/4" to flat sealing
 Adapter kunststof EK 3/4" naar vlakdichtend
 Adaptateur EK 3/4" vers joint plat
 Adapter von EK 3/4" nach AG flachdichtend

Article number	Bag / Box	Type
■ AK-EK05VD	50 pc. / 1000 pc.	



CERTIFICATES - CERTIFICATEN - APPROBATIONS - ZERTIFIKATE



GERMANY



AUSTRIA



FRANCE



THE NETHERLANDS

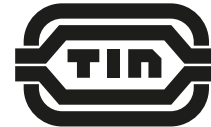

POLAND



DENMARK



ITALY



RUSSIA



SLOVAKIA



ATG SYSTEM CERTIFICATE BELGIUM



NORWAY



FINLAND



HUNGARY



ENGLAND



SWEDEN



USA



ESTONIA



SPAIN



CZECH REPUBLIC



SOUTH AFRICA

INDEX

Article number	Page	Article number	Page	Article number	Page	Article number	Page
03-160212	6	100-ISO4-14-BL	7	10PK-633263	25	11PK-262016	26
03-180214	6	100-ISO4-14-RO	7	10PK-634063	25	11PK-262020	26
03-200216	6	100-ISO4-16-BL	7	10PK-635063	25	11PK-262616	26
03-260320	6	100-ISO4-16-RO	7	10PK-754075	25,47	11PK-262620	26
03-320326	6	100-ISO4-R16-BL	13	10PK-755075	25,47	11PK-322026	26
03-403533	6	100-ISO4-R16-RO	13	10PK-756375	25,47	11PK-322626	26
03-504042	6	100-MB	18	10PK-904090	25,47	11PK-402032	26
03-634554	6	100-MBLACK	18	10PK-905090	25,47	11PK-402632	26
03-R160212	12	100-MG16	18	10PK-906390	25,47	11PK-403232	26
03-R200216	12	100-MR	18	10PK-907590	25,47	11PK-404026	26
03-R260320	12	100-R160212	12	10PKG-201620	43	11PK-404032	26
04-160212	6	100-R16MB	14	10PKG-261626	43	11PK-502040	26
04-180214	6	100-R16MBLACK	14	10PKG-262026	43	11PK-502640	26
04-200216	6	100-R16MR	14	10PKG-321632	43	11PK-503240	26
04-260320	6	100-R180214	12	10PKG-322032	43	11PK-504040	26
04-320326	6	100-R18MR	14	10PKG-322632	43	11PK-754040	26,47
04-403533	6	100-R200216	12	10PKG-401640	43	11PK-754050	26,47
04-504042	6	100-R20MB	14	10PKG-402040	43	11PK-754063	26,47
04-634554	6	100-R20MR	14	10PKG-402640	43	11PK-755050	26,47
04-R160212	12	10-160212-KB	5	10PKG-403240	43	11PK-755063	26,47
04-R200216	12	10-1604SN	89	10PKW-201620	36	11PK-756363	26,47
04-R260320	12	10P-161416	70	10PKW-261626	36	11PK-904040	26,47
05-160212	6	10P-181418	70	10PKW-262026	36	11PK-904050	26,47
05-160212-GAS	19	10P-181618	70	10PKW-321632	36	11PK-904050	26,47
05-180214	6	10P-201620	70	10PKW-322032	36	11PK-904063	26,47
05-200216	6	10P-201820	70	10PKW-322632	36	11PK-904075	26,47
05-200216-GAS	19	10P-261626	70	10-R160212-KB	12	11PK-905050	26,47
05-260320	6	10P-261826	70	10SK-201620	56	11PK-905063	26,47
05-260320-GAS	19	10P-262026	70	10SK-261626	56	11PK-905075	26,47
05-320326	6	10P-321632	70	10SK-262026	56	11PK-906363	26,47
05-320326-GAS	19	10P-321832	70	11-200420	89	11PK-906375	26,47
05-403533	6	10P-322032	70	11-260526	89	11PK-907575	26,47
05-403533-GAS	19	10P-322632	70	11-260626	89	11PKG-201616	43
05-504042	6	10PG-262026	82	1-1403C	86	11PKG-202016	43
05-634554	6	10PK-161416	25	1-1404	86	11PKG-261620	43
05-756063	6	10PK-16JG1016	25	1-1604	86	11PKG-262016	43
05-907076	6	10PK-181418	25	1-1604Z	86	11PKG-262020	43
05-R160212	12	10PK-181618	25	1-1605	86	11PKG-262616	43
05-R200216	12	10PK-201420	25	1-1804	86	11PKG-262620	43
05-R260320	12	10PK-201620	25	1-1805	86	11PKG-322026	43
100-014MB	9	10PK-201820	25	11P-181616	70	11PKG-322626	43
100-014MBLACK	9	10PK-20JG1020	25	11P-201616	70	11PKG-402032	43
100-014MR	9	10PK-261626	25	11P-201818	70	11PKG-402632	43
100-016MB	9	10PK-261826	25	11P-202016	70	11PKG-403232	43
100-016MBLACK	9	10PK-262026	25	11P-261620	70	11PKG-404026	43
100-016MR	9	10PK-321632	25	11P-262020	70	11PKG-404032	43
100-018MB	9	10PK-321832	25	11P-262616	70	11PKW-201616	37
100-018MR	9	10PK-322032	25	11P-262620	70	11PKW-202016	37
100-020MB	9	10PK-322632	25	11P-322026	70	11PKW-261616	37
100-020MR	9	10PK-401640	25	11P-322626	70	11PKW-261620	37
100-121688	5	10PK-402040	25	11PG-201616	82	11PKW-262016	37
100-140210	5	10PK-402640	25	11PK-161414	26	11PKW-262020	37
100-160212	5	10PK-403240	25	11PK-181616	26	11PKW-262616	37
100-180214	5	10PK-502050	25	11PK-201616	26	11PKW-262620	37
100-200216	5	10PK-502650	25	11PK-201818	26	11PKW-322026	37
100-F16R-WZ	15	10PK-503250	25	11PK-202016	26	11PKW-322626	37
100-F20R-WZ	15	10PK-504050	25	11PK-261616	26	11SK-201616	57
100-FLEX26	10	10PK-632663	25	11PK-261620	26	11SK-202016	57

INDEX

Article number	Page	Article number	Page	Article number	Page	Article number	Page
11SK-261620	57	13PK-180418BP	27	14P-260426	71	15PK-4040	29
11SK-262016	57	13PK-200420BP	27	14P-260526	71	15PK-5050	29
11SK-262020	57	13PK-200520	27	14P-260626	71	15PK-6363	29
11SK-262616	57	13PK-260420BP	27	14P-320532	71	15PK-7575	29,48
11SK-262620	57	13PK-260426BP	27	14P-320632	71	15PK-9090	29,48
1-2004	86	13PK-260526	27	14PK-160416	28	15PKG-1616	44
1-2004Z	86	13PK-320532	27	14PK-180418	28	15PKG-2020	44
1-2005	86	13PK-320632	27	14PK-200420	28	15PKG-2626	44
120-PRT1620	17	13PK-320732	27	14PK-200520	28	15PKG-3232	44
1-2605	86	13PK-400640	27	14PK-260426	28	15PKG-4040	44
1-2606	86	13PK-400640-N	28	14PK-260526	28	15PKW-1616	38
12P-161816	70	13PK-400740	27	14PK-260626	28	15PKW-2020	38
12P-162016	70	13PK-400740-N	28	14PK-320532	28	15PKW-2626	38
12P-202620	70	13PK-500850	27	14PK-400640	28	15PKW-3232	38
12P-263226	70	13PK-500850-N	28	14PK-400640-N	28	15-R160212-KB	12
12PK-161816	27	13PK-631063	27	14PK-400740	28	15SK-1616	58
12PK-162016	27	13PK-631063-N	28	14PK-400740-N	28	15SK-2020	58
12PK-202620	27	13PK-750675	27,48	14PK-500850	28	15SK-2626	58
12PK-263226	27	13PK-751075	27,48	14PK-500850-N	28	16HNB	50
12PK-324032	27	13PK-751275	27,48	14PK-631063	28	16P-1614	72
12PK-405040	27	13PK-901490	27,48	14PK-631063-N	28	16P-1816	72
12PK-407540	27,47	13PKG-160416BP	44	14PK-751075	28,48	16P-2014	72
12PK-409040	27,47	13PKG-200420BP	44	14PK-751275	28,48	16P-2016	72
12PK-507550	27,47	13PKG-200520	44	14PKG-160416	44	16P-2018	72
12PK-509050	27,47	13PKG-260420BP	44	14PKG-200420	44	16P-2616	72
12PK-637563	27,47	13PKG-260426BP	44	14PKG-200520	44	16P-2618	72
12PK-639063	27,47	13PKG-260526	44	14PKG-260426	44	16P-2620	72
12PK-759075	27,47	13PKG-320532	44	14PKG-260526	44	16P-3216	72
12PKG-162016	43	13PKG-320632	44	14PKG-260626	44	16P-3220	72
12PKG-202620	43	13PKG-320732	44	14PKG-320532	44	16P-3226	72
12PKG-263226	43	13PKG-400640	44	14PKG-400740	44	16PG-2016	83
12PKG-324032	43	13PKG-400740	44	14PKW-160416	38	16PG-2620	83
12PKW-162016	37	13PKW-160416	37	14PKW-160416-N	38	16PG-3226	83
12PKW-202620	37	13PKW-160416-N	38	14PKW-200420	38	16PK-1614	29
12PKW-263226	37	13PKW-200420	37	14PKW-200420-N	38	16PK-1814	29
12SK-162016	57	13PKW-200420-N	38	14PKW-200520	38	16PK-1816	29
12SK-202620	57	13PKW-200520	37	14PKW-200520-N	38	16PK-2014	29
13-1415	89	13PKW-200520-N	38	14PKW-320532	38	16PK-2016	29
13-1615A	89	13PKW-260426	37	14SK-160416	57	16PK-2018	29
13-1615HA	89	13PKW-260426-N	38	14SK-200420	57	16PK-2616	29
13-2022HA	89	13PKW-260526	37	14SK-260426	57	16PK-2618	29
1-3206	86	13PKW-260526-N	38	15-160212-KB	5	16PK-2620	29
13-2628H	89	13PKW-320532	37	15P-1414	71	16PK-3216	29
13P-160416	71	13PKW-320532-N	38	15P-1616	71	16PK-3220	29
13P-200420	71	13PKW-320632	37	15P-1818	71	16PK-3226	29
13P-200520	71	13PKW-320632-N	38	15P-2020	71	16PK-4026	29
13P-260420	71	13SK-160416BP	57	15P-2626	71	16PK-4032	29
13P-260426	71	13SK-200420BP	57	15P-3232	71	16PK-5032	29
13P-260526	71	13SK-200520	57	15PG-1616	83	16PK-5040	29
13P-320532	71	13SK-260420BP	57	15PG-2020	83	16PK-6340	29
13P-320632	71	13SK-260426BP	57	15PG-2626	83	16PK-6350	29
13P-320732	71	13SK-260526	57	15PG-3232	83	16PK-7540	29,48
13PG-200420	83	13-V2622H	90	15PK-1414	29	16PK-7550	29,48
13PG-200520	83	13-V2622H-2	90	15PK-1616	29	16PK-7563	29,48
13PG-260426	83	14P-160416	71	15PK-1818	29	16PK-9040	29,48
13PG-260526	83	14P-180418	71	15PK-2020	29	16PK-9050	29,48
13PG-320632	83	14P-200420	71	15PK-2626	29	16PK-9063	29,48
13PK-160416BP	27	14P-200520	71	15PK-3232	29	16PK-9075	29,48

INDEX

Article number	Page	Article number	Page	Article number	Page	Article number	Page
16PKG-2016	45	17PK-6310-N	30	18PG-2606	84	19P-2005	73
16PKG-2616	45	17PK-7510	30,49	18PG-3206	84	19PK-1605	31
16PKG-2620	45	17PK-7512	30,49	18PK-1404	31	19PK-2005	31
16PKG-3216	45	17PKG-1604	45	18PK-1604	31	19PKW-1605	40
16PKG-3220	45	17PKG-2004	45	18PK-1804	31	19PKW-2005	40
16PKG-3226	45	17PKG-2005	45	18PK-1805	31	19SK-1605	59,62
16PKG-4026	45	17PKG-2605	45	18PK-2004	31	19SK-2005	59,62
16PKG-4032	45	17PKG-2606	45	18PK-2005	31	1HNA	50
16PKW-2016	39	17PKG-3206	45	18PK-2605	31	1HNB	50
16PKW-2620	39	17PKG-3207	45	18PK-2606	31	1P-1414	67
16PKW-3216	39	17PKG-4006	45	18PK-3206	31	1P-1616	67
16PKW-3220	39	17PKG-4007	45	18PK-3207	31	1P-1818	67
16PKW-3226	39	17PKW-1604	39	18PK-4006	31	1P-2020	67
16SK-2016	58	17PKW-1604-N	39	18PK-4006-N	31	1P-2626	67
16SK-2616	58	17PKW-2004	39	18PK-4007	31	1P-3232	67
16SK-2620	58	17PKW-2004-N	39	18PK-4007-N	31	1PG-1616	81
17HNA-10	51	17PKW-2005	39	18PK-5008	31	1PG-2020	81
17HNA-10-N	51	17PKW-2005-N	39	18PK-5008-N	31	1PG-2626	81
17HNA-12	51	17PKW-2605	39	18PK-6310	31	1PK-1414	21
17HNA-12-N	51	17PKW-2605-N	39	18PK-6310-N	31	1PK-1616	21
17P-1403	72	17PKW-2606	39	18PK-7506	31,49	1PK-16JG10	21
17P-1404	72	17PKW-2606-N	39	18PK-7510	31,49	1PK-1818	21
17P-1603	72	17PKW-3206	39	18PK-7512	31,49	1PK-2020	21
17P-1603DZR	72	17PKW-3206-N	39	18PK-9014	31,49	1PK-20JG10	21
17P-1604	72	17PKW-3207	39	18PKG-1604	45	1PK-2626	21
17P-1604DZR	72	17PKW-3207-N	39	18PKG-2004	45	1PK-3232	21
17P-1603	72	17SK-1603	58	18PKG-2005	45	1PK-4040	21
17P-1804	72	17SK-1604	58	18PKG-2605	45	1PK-5050	21
17P-1805	72	17SK-2004	58	18PKG-2606	45	1PK-6363	21
17P-2004	72	17SK-2005	58	18PKG-3206	45	1PK-7575	21,47
17P-2005	72	17SK-2605	58	18PKG-3207	45	1PK-9075	21,47
17P-2605	72	17SK-2606	58	18PKG-4006	45	1PK-9090	21,47
17P-2606	72	17SKS-2004	59,62	18PKG-4007	45	1PKG-1616	41
17P-3206	72	17SKS-2005	59,62	18PKW-1604	40	1PKG-2020	41
17P-3207	72	17SKS-2604	59,62	18PKW-1604-N	40	1PKG-2626	41
17PG-1604	83	17SKS-2605	59,62	18PKW-2004	40	1PKG-3232	41
17PG-2004	83	18HNA-06	52	18PKW-2004-N	40	1PKG-4040	41
17PG-2005	83	18HNA-06-N	52	18PKW-2005	40	1PKW-1616	34
17PG-2605	83	18HNA-10	52	18PKW-2005-N	40	1PKW-2020	34
17PG-2606	83	18HNA-10-N	52	18PKW-2605	40	1PKW-2626	34
17PG-3206	83	18HNA-12	52	18PKW-2605-N	40	1PKW-3232	34
17PK-1404	30	18HNA-12-N	52	18PKW-2606	40	1SK-1616	55
17PK-1604	30	18HNB-14	52	18PKW-2606-N	40	1SK-2020	55
17PK-1804	30	18HNB-14-N	52	18PKW-3206	40	1SK-2626	55
17PK-1805	30	18P-1404	73	18PKW-3206-N	40	200-121688	5
17PK-2004	30	18P-1604	73	18PKW-3207	40	200-140210	5
17PK-2005	30	18P-1804	73	18PKW-3207-N	40	200-160212	5
17PK-2605	30	18P-1805	73	18SK-1604	58	200-180214	5
17PK-2606	30	18P-2004	73	18SK-2004	58	200-F16R-WZ	15
17PK-3206	30	18P-2005	73	18SK-2005	58	200-F20R-WZ	15
17PK-3207	30	18P-2605	73	18SK-2605	58	200-PRT1620	17
17PK-4006	30	18P-2606	73	18SK-2606	58	200-PXC1620	16
17PK-4006-N	30	18P-3206	73	18SKS-2004	59,63	200-PXC1720	16
17PK-4007	30	18P-3207	73	18SKS-2005	59,63	200-PXC2020	16
17PK-4007-N	30	18PG-1604	84	18SKS-2604	59,63	200-R160212	12
17PK-5008	30	18PG-2004	84	18SKS-2605	59,63	200-R180214	12
17PK-5008-N	30	18PG-2005	84	19P-1605	73	20P-1604	73
17PK-6310	30	18PG-2605	84	19P-1805	73	2-1616	86

INDEX

Article number	Page	Article number	Page	Article number	Page	Article number	Page
2-1818	86	25-R160212-KB	12	28PV-16041604-1	76	31P-201620	77
21P-1504	73	25-R16MB	14	29P-1612-CS	76	31P-202020	77
2-2020	86	25-R16MR	14	29P-1615-CS	76	3-2004	86
2-2626	86	25-R20MB	14	29P-2018-CS	76	3-2005	86
22P-1604	74	25-R20MBLACK	14	29P-2022-CS	76	3-2605	86
22P-2004	74	25-R20MR	14	29P-2622-CS	76	3-2606	86
2-3232	86	26P-14Z04	76	2P-1404K	67	3-3206	86
240-PXC1820	16	26P-1604	74	2P-1604	67	33P-1605	77
24-1615	90	26P-1605	74	2P-1604K	67	34P-1604	78
24-2022	90	26P-16Z03	75	2P-1804	67	34P-1605	78
24-2622	90	26P-16Z04	75	2P-2004	67	34P-1605-CS	78
24-2628	90	26P-16Z05	75	2P-2005	67	34P-2004-CS	78
24P-1604	74	26P-1805	74	2P-2605	67	34P-2005	78
24P-1804	74	26P-18Z05	75	2PG-1604	81	34P-2005-CS	78
24P-2004	74	26P-2004	74	2PG-1604K	81	34P-2605-CS	78
25-014MB	9	26P-2005	74	2PG-2004	81	34P-3206	78
25-014MR	9	26P-20Z04	75	2PG-2005	81	35P-1615P	78
25-016GASMG	19	26P-20Z05	75	2PG-2605	81	35P-2018P	78
25-016MB	9	26P-2605	74	2PK-1404BP	21	35P-2022P	78
25-016MB-KB	10	26P-2606	74	2PK-1603	21	35P-3228P	78
25-016MR	9	26P-26Z05	75	2PK-1604BP	21	36P-1612P	78
25-016MR-KB	10	26P-26Z06	75	2PK-1604KBP	22	36P-1614P	78
25-020GASMG	19	26P-3206	74	2PK-1804BP	21	36P-1615P	78
25-020MB	9	26P-32Z06	75	2PK-2004BP	21	36P-1616P	78
25-020MBLACK	9	26P-32Z07	75	2PK-2005	21	36P-2015P	78
25-020MR	9	26PK-1605	32	2PK-2605	21	36P-2018P	78
25-026MB	9	26PK-2005	32	2PKG-1603	41	36P-2022P	78
25-026MR	9	26PK-4008	32	2PKG-1604BP	41	36P-2622P	78
25-032GASMG	19	26PK-5010	32	2PKG-1604KBP	41	36P-3228P	78
25-032MB	9	26PK-6312	32	2PKG-2004BP	41	36PG-1615P	84
25-032MR	9	26PKW-1605	40	2PKG-2005	41	36PG-2015P	84
25-160212-GAS	19	26PKW-2005	40	2PKG-2605	41	36PG-2022P	84
25-160212-KB	5	26SK-1605	59	2PKW-1604	34	36PG-2615P	84
25-200216	5	26SK-2005	59	2PKW-1604K	34	36PG-2622P	84
25-200216-KB	5	27HNA	50	2PKW-1604-N	34	37P-1412L	79
25-ISO13-32-BL	8	27HNB	50	2PKW-2004	34	37P-1612L	79
25-ISO13-E20-BL	8	27P-2626	75	2PKW-2004-N	34	37P-1615L	79
25-ISO13-E26-BL	8	27P-3232	75	2PKW-2005-N	34	39P-160450	79
25-ISO26-E16-BL	8	27PK-4040	32	2PKW-2605-N	34	3EK-050405	93
25-ISO26-E20-BL	8	27PK-5050	32	2S-1604K	55	3P-160416	67
25-ISO26-E26-BL	8	27PK-6363	32	2SK-1604BP	55	3P-160416VK	68
25-ISO4-26-BL	7	27PK-7575	32,49	2SK-2004BP	55	3P-200420	67
25-ISO4-26-RO	7	27PK-9090	32,49	2SK-2005	55	3P-200420VK	68
25-ISO4-32-BL	7	27PKG-4040	46	2SK-2605	55	3PG-160416	81
25-ISO4-32-RO	7	28-201620	90	30P-1614S	76	3PG-200420	81
25-ISO4-R26-BL	13	28-202016	90	30P-1615S-2	76	3PK-160416BP	22
25-ISO4-R26-RO	13	28-262026	90	30P-2022S	76	3PK-200420BP	22
25-ISO9-26-BL	7	28-322632	90	30P-2622S	76	3PKG-200420BP	42
25-ISO9-26-RO	7	28P-14041604-1	75	30PG-1615S	84	3PKW-160416	35
25-ISO9-32-BL	7	28P-16041604-1	75	30PG-2022S	84	3PKW-160416-N	35
25-ISO9-32-RO	7	28PF-16041604	76	30PG-2622S	84	3PKW-200420	35
25-ISO9-R26-BL	13	28PF-20042004	76	3-1403C	86	3PKW-200420-N	35
25-ISO9-R26-RO	13	28PK-04	32	3-1404	86	3PM-200420V	68
25-MB32	18	28PK-6PK1604BP	33	3-1604	86	3SK-160416BP	55
25-MG32	18	28PK-13PK1604BP	33	3-1804	86	3SK-200420BP	55
25-MR32	18	28PV-16031603	76	31P-161616	77	400-F20R-WZ	15
25P-1604	74	28PV-16031603-1	76	31P-161620	77	40P-1615S	77
25P-2004	74	28PV-16041604	76	31P-201616	77	40P-2022S	77

INDEX

Article number	Page	Article number	Page	Article number	Page	Article number	Page
40P-2622S	77	50-ISO4-18-BL	7	53PK63	33	6-1604	87
4-1414	87	50-ISO4-18-RO	7	5P-1404	68	6-1804	87
4-1616	87	50-ISO4-20-BL	7	5P-1603	68	6-2004	87
41P-16	79	50-ISO4-20-RO	7	5P-1604	68	6-2005	87
41P-20	79	50-ISO4-26-BL	7	5P-1804	68	6-2605	87
41P-26	79	50-ISO4-26-RO	7	5P-2004	68	6-2606	87
41S-20	65	50-ISO4-R18-BL	13	5P-2005	68	6-3206	87
41S-26	65	50-ISO4-R18-RO	13	5P-2605	68	6P-1404	69
41SKS-20	65	50-ISO4-R20-BL	13	5P-3206	68	6P-1604	69
41SKS-26	65	50-ISO4-R20-RO	13	5PG-1604	82	6P-1804	69
4-2020	87	50-ISO4-R26-BL	13	5PG-2004	82	6P-2004	69
4-2626	87	50-ISO4-R26-RO	13	5PG-2005	82	6P-2005	69
42P-161615	80	50-ISO9-14-BL	7	5PG-2605	82	6P-2605	69
42P-202019	80	50-ISO9-14-RO	7	5PK-1404	23	6P-3206	69
4-3232	87	50-ISO9-16-BL	7	5PK-1604	23	6PG-1604	82
4P-1604	68	50-ISO9-16-RO	7	5PK-1804	23	6PG-2004	82
4P-1804	68	50-ISO9-18-BL	7	5PK-2004	23	6PG-2005	82
4P-2004	68	50-ISO9-20-BL	7	5PK-2005	23	6PG-2605	82
50-014MB	9	50-ISO9-20-RO	7	5PK-2605	23	6PK-1404BP	23
50-014MBLACK	9	50-ISO9-26-BL	7	5PK-3206	23	6PK-1603	23
50-014MR	9	50-ISO9-26-RO	7	5PK-4007	23	6PK-1604BP	23
500-160212D	5	50-ISO9-R16-BL	13	5PK-4007-N	23	6PK-1804BP	23
50-016GASMG	19	50-ISO9-R16-RO	13	5PK-5007	23	6PK-2004BP	23
50-016MB	9	50-ISO9-R18-BL	13	5PK-5007-N	23	6PK-2005	23
50-016MBLACK	9	50-ISO9-R20-BL	13	5PK-5008	23	6PK-2605	23
50-016MR	9	50-ISO9-R20-RO	13	5PK-5008-N	23	6PK-3206	23
50-018MB	9	50-MB20	18	5PK-6310	23	6PK-4007	23
50-018MR	9	50-MB26	18	5PK-6310-N	23	6PK-4007-N	24
50-020GASMG	19	50-MBLACK20	18	5PK-7510	23,47	6PK-5007	23
50-020MB	9	50-MBLACK26	18	5PK-7512	23,47	6PK-5007-N	24
50-020MBLACK	9	50-MG16	18	5PKG-1604	42	6PK-5008	23
50-020MR	9	50-MG20	18	5PKG-2004	42	6PK-5008-N	24
50-026GASMG	19	50-MG26	18	5PKG-2005	42	6PK-6310	23
50-026MB	9	50-MR20	18	5PKG-2605	42	6PK-6310-N	24
50-026MBLACK	9	50-MR26	18	5PKG-3206	42	6PK-7506	23,47
50-026MR	9	50-R160212	12	5PKG-4007	42	6PK-7510	23,47
500-F16R-WZ	15	50-R16MB	14	5PKW-1604	35	6PK-7512	23,47
500-R160212D	12	50-R16MBLACK	14	5PKW-1604-N	35	6PK-9014	23,47
50-140210	5	50-R16MR	14	5PKW-2004	35	6PKG-1604BP	42
50-160212	5	50-R18MB	14	5PKW-2004-N	35	6PKG-2004BP	42
50-160212-GAS	19	50-R18MR	14	5PKW-2005	35	6PKG-2005	42
50-200216	5	50-R20MB	14	5PKW-2005-N	35	6PKG-2605	42
50-200216-GAS	19	50-R20MR	14	5PKW-2605	35	6PKG-3206	42
50-260320	5	50-R260320	12	5PKW-2605-N	35	6PKG-4007	42
50-260320-GAS	19	50-R26MB	14	5PKW-3206	35	6PKW-1603	36
50-320326	5	50-R26MR	14	5PKW-3206-N	35	6PKW-1603-N	36
50-320326-GAS	19	5-1604	87	5SK-1604	56	6PKW-1604	36
50-COMBI16	9	5-1804	87	5SK-2004	56	6PKW-1604-N	36
50-COMBI16R	14	5-2005	87	5SK-2005	56	6PKW-2004	36
50-ISO13-16-BL	8	5-2605	87	5SK-2605	56	6PKW-2004-N	36
50-ISO13-18-BL	8	5-2606	87	600-PRT1620	17	6PKW-2005	36
50-ISO13-20-BL	8	52P16	79	600-PRT1720	17	6PKW-2005-N	36
50-ISO13-26-BL	8	52P20	79	600-PRT1820	17	6PKW-2605	36
50-ISO13-E16-BL	8	52P26	79	600-PRT2020	17	6PKW-2605-N	36
50-ISO13-E18-BL	8	52P32	79	600-PXC1620	16	6PKW-3206	36
50-ISO13-R16-BL	13	5-3206	87	600-PXC1720	16	6PKW-3206-N	36
50-ISO13-R20-BL	13	53PK40	33	600-PXC2020	16	6SK-1604BP	56
50-ISO13-R26-BL	13	53PK50	33	6-1404	87	6SK-2004BP	56

INDEX

Article number	Page	Article number	Page	Article number	Page	Article number	Page
6SK-2005	56	9SK-202020	56	BE16H	153,	BE-UNISET2	151
6SK-2605	56	9SK-262626	56		157,	BI-1410	144
7-1404	88	AB1420	92		158	BI-1612	144
7-1604	88	ABEK04	92	BE16M	162	BI-1612L	144
7-160416	88	AD-EKEK	92	BE16MINI	158	BI-1814	144
7-1804	88	AK-EK05VD	168	BE16MINI3	156	BI-2016	144
7-2004	88	AN1420	93	BE18	151	BI-2016L	144
7P-1605	69	AT1420	92	BE18C	159	BI-2620	144
7P-1605K	69	BA-1288	144	BE18H	153,	BM-16	144
7P-1805	69	BA-1410	144		157,	BM-20	144
7P-2005	69	BA-1612	144		158	BM-26	144
8-161616	88	BA-1814	144	BE18HM	153,	BPO4	22
8-181818	88	BA-2016	144		157,	CU-10ZONEK-230V	133
8-202020	88	BA-F41	105		159	CU-10ZONEK-24V	133
8HNA-PK40	50	BA-F41	105	BE18M	162	CU-12ZONE-RF	137
8HNA-PK50	50	BAP-CC2626	104	BE18V-MINI3	156	CU-6ZONE-230V	131
8HNA-PK63	50	BAP-CH1616	104	BE20	151	CU-6ZONE-24V	131
8HNA-PK75	50	BAP-CH2626	104	BE20H	153,	CU-6ZONEK-230V	132
8HNB-PK90	50	BAP-CS1616	106		157,	CU-6ZONEK-24V	132
8P-1604	69	BAP-CS1818	106	BE20M	158	CU-6ZONEP-230V	131
9-140414	89	BAP-CS2020	106	BE20MINI	158	CU-6ZONEP-24V	131
9-160416	89	BAP-CS2626	106	BE20MINI3	156	CU-8ZONEB-RF	137
9-200420	89	BAP-H1616	103	BE22C	159	CU-8ZONE-RF	137
9-200520	89	BAP-H1818	103	BE22HC	153,	CU-ACT-230V	134
9-200520	89	BAP-H2020	103		157,	CU-ACT-230V-PLUG	135
9-260526	89	BAP-H2626	103		158	CU-ACT-230V-PLUG	135, 139
9HNA	50	BAP-H3232	103	BE22HM	153,	CU-ACT-24V-PLUG	135
9HNB	50	BAP-H3232	103		157,	CU-ANT	138
9P-141414	69	BAP-SK1616	104		159	CU-DINRAIL	132, 133
9P-161616	69	BAP-SK2020	104	BE22HM	153,	CU-MONO-RF	137
9P-161616	69	BAP-SK2626	104		157,	CU-PLUGCABLE-15M	135, 139
9P-181818	69	BAP-SV1610S	104		159	CU-PLUGCABLE-2M	135, 139
9P-202020	69	BCLIP-14	166	BE22MMINI	158	CU-PLUGCABLE-5M	135, 139
9P-262626	69	BCLIP-16	166			CU-REGB-230V	133
9P-323232	69	BCLIP-1820	166	BE22V-MINI3	156	CU-REGB-24V	133
9PG-161616	82	BCLIP-26	166	BE26	151	CU-REGB-HC230V	134
9PG-202020	82	BCLIP-32	166	BE26H	153,	CU-REGB-HC24V	134
9PG-262626	82	BCLIP-40	166		157,	CU-REGB-RF	137
9PG-323232	82	BCLIP-50	166	BE26MINI	158	CU-REGC-230V	134
9PK-141414	24	BE12HC	153,	BE26MINI3	156	CU-REGC-24V	134
9PK-161616	24		157,	BE28C	159	CU-REGC-RF	138
9PK-181818	24	BE12HM	158,	BE28HC	153,	CU-REGK-230V	134
9PK-202020	24		157,		157,	CU-REGK-24V	134
9PK-262626	24	BE14	159	BE28V-MINI3	156	CU-REGS-RF	138
9PK-323232	24	BE14H	151	BE32	151	CU-REPEAT	138
9PK-404040	24		153,	BE32H	153,	CU-SENS	138
9PK-505050	24		157,		157,	DRILLY14	162
9PK-636363	24	BE14M	158	BE32MINI	158	DRILLY16	162
9PK-757575	24,47	BE15C	162	BE32MINI3	156	DRILLY18	162
9PK-909090	24,47	BE15HC	159	BE40	151	DRILLY20	162
9PKG-161616	42		153,	BE50	151	DRILLY26	162
9PKG-202020	42	BE15HM	157,	BE63	151	DRILLY32	162
9PKG-262626	42		158	BE-BOX	153	EK12-2	91
9PKG-323232	42		158	BE-MINI	159	EK14-2	91
9PKG-404040	42		159	BE-MINI3	156	EK15	91, 101
9PKW-161616	36	BE15MMINI	158	BE-UNI	152	EK16-2	91
9PKW-202020	36	BE15V-MINI3	156	BE-UNISET1	151	EK17-2	91
9PKW-262626	36	BE16	151			EK18-2	91
9PKW-323232	36						
9SK-161616	56						

INDEX

Article number	Page	Article number	Page	Article number	Page	Article number	Page
EK20-2	91	M-LAD	149	SK-STOPCLIP20	64	UFH-0505CDP14	124
EKH16-2	91	M-LAD03	149	SK-STOPCLIP26	60	UFH-0505CDP15	124
ENDCAP-EK05	64	M-LADMINI2	157	SK-STOPCLIP26	64	UFH-0505CDP16	124
H-0212	97	M-LADMINI3	155	SPLIT-S16	91	UFH-0505CDWE01	125
H-0212-S	97	M-TRANS	150	SPLIT-S20	91	UFH-0505CDWE03	125
HNA	51	M-TRANS03	149	TESTPLUG16	168	UFH-0505CDWE06	125
HNA-ECOLINE-SET	53	M-TRANSMINI2	157	TESTPLUG20	168	UFH-0505CDWE08	125
HNA-EK05	52	M-TRANSMINI3	155	TOOLBOX16202632	152	UFH-0505CDWE09	125
HNA-STOP	52	N04	75	TOOLBOX405063	152	UFH-0505S07	126
HNA-U	51	N05	75	UFH-0405CDP01	124	UFH-0505S08	126
HNB	51	N0605	75	UFH-0405CDP02	124	UFH-0505S09	126
HNB-STOP	52	NCLIP-1618	167	UFH-0405CDP03	124	UFH-0505S10	126
HNB-U	51	NCLIP-20	167	UFH-0405CDP04	124	UFH-0505S11	126
HN-PEN	51	NCLIP-20DOUBLE	167	UFH-0405CDP05	124	UFH-0505S12	126
HNTOOLSET	164	NCLIP-26	167	UFH-0405CDP06	124	UFH-0505S13	126
ISO-BLOCK-L	11	PH-1632	148	UFH-0405CDP06	124	UFH-0505S14	126
ISO-BLOCK-S	10	PIPEPLUG16	167	UFH-0405LTV01	128	UFH-0505S14	126
ISO-BOX	77	PK-TOOL04	164	UFH-0405LTV02	128	UFH-0505S15	126
JCLIP-1632	166	PK-TOOL05	164	UFH-0405LTV03	128	UFH-0505S16	126
JCLIP-1632D	166	PK-TOOL06	164	UFH-0405LTV04	128	UFH-0505SECC07	126
JCLIP-1632DL	167	PK-TOOLBOX	164	UFH-0405LTV05	128	UFH-0505SECC08	126
JCLIP-1632L	166	PK-TOOLBOX040506	164	UFH-0405LTV06	128	UFH-0505SECC09	126
KS12M	147	PLF-P-PK	168	UFH-0405LTV07	128	UFH-0505SECC10	126
KS14M	147	PLP-P-PK	168	UFH-0405LTV08	128	UFH-0505SECC11	126
KS16M	147	PLUG04-B55	162	UFH-0405LTV09	128	UFH-0505SECC12	126
KS18M	147	PLUG04-B80	162	UFH-0405LTV10	128	UFH-0505SECC13	126
KS20M	147	PLUG04-R80	162	UFH-0405LTV11	128	UFH-0505SECC14	126
KS26M	147	PLUG05-B80	162	UFH-0405LTV12	128	UFH-0505SECC15	126
KS32M	147	PLUG05-R80	162	UFH-0405S01	126	UFH-0505SECC16	126
KS40M	147	PRESSCHECK1432	162	UFH-0405S02	126	UFH-0505SSTE07	127
KS50	147	PS-16	146	UFH-0405S03	126	UFH-0505SSTE08	127
KS63	147	RAD04-100H	101	UFH-0405S04	126	UFH-0505SSTE09	127
KS-K	147	RAD04-100V	101	UFH-0405S05	126	UFH-0505SSTE10	127
KS-MSET1	146	RAD-B	103	UFH-0405S06	126	UFH-0505SSTE11	127
KS-MSET4	146	RAD-H	103	UFH-0405SEC001	126	UFH-0505SSTE12	127
KS-P162026	147	RADH-100H	102	UFH-0405SEC002	126	UFH-0505SSTN07	127
LB50	10	RADH-100V	102	UFH-0405SEC003	126	UFH-0505SSTN08	127
M-BA03	148	RADK2-R	101	UFH-0405SEC004	126	UFH-0505SSTN09	127
M-BAT	149	RADNI-0504	103	UFH-0405SEC005	126	UFH-0505SSTN10	127
M-BAT03	148	RADTH-VL	102	UFH-0405SEC006	126	UFH-0505SSTN11	127
M-BATMINI	158	RADV-2-R	102	UFH-0405SSTE01	127	UFH-0505SSTN12	127
M-BATMINI2	157	RS1420PRESS	144	UFH-0405SSTE02	127	UFH-060502-MD	119
M-BATMINI3-1.5AH	155	RS1420PRESS-N	145	UFH-0405SSTE03	127	UFH-060502-MR	119
M-BATMINI3-3.0AH	155	RS2640PRESS	144	UFH-0405SSTE04	127	UFH-060502-RVSD	122
M-BH162026	160	RS32	145	UFH-0405SSTE05	127	UFH-060503-MD	119
M-BHY	150	RS63	145	UFH-0405SSTE06	127	UFH-060503-MR	119
M-BHY162026	150	RSEM1420-PERS	145	UFH-0405SSTN01	127	UFH-060503-RVSD	122
M-BM1620	161	RSEM2640-PERS	145	UFH-0405SSTN02	127	UFH-060504-MD	119
M-BMINI2-SLB	157	RSEM32	145	UFH-0405SSTN03	127	UFH-060504-MR	119
M-BMINI3	154	RSEM63	145	UFH-0405SSTN04	127	UFH-060504-RVSD	122
M-BMINI3-F	154	SAFECUT	146	UFH-0405SSTN05	127	UFH-060505-MD	119
M-BMINI3-S	154	SK-B05	65	UFH-0405SSTN06	127	UFH-060505-MR	119
M-BOXBA03	149	SK-PIPESTOP16	60	UFH-0505CDP07	124	UFH-060505-RVSD	122
M-BOXBHY	150	SK-PIPESTOP20	60	UFH-0505CDP08	124	UFH-060506-MD	119
M-BOXMINI2	158	SK-PIPESTOP26	60	UFH-0505CDP09	124	UFH-060506-MR	119
M-BOXMINI3	155	SK-STOPCLIP16	60	UFH-0505CDP10	124	UFH-060506-RVSD	122
M-BOXMINI3-F	156	SK-STOPCLIP16	64	UFH-0505CDP11	124	UFH-060507-MD	119
M-HP32	160	SK-STOPCLIP20	60	UFH-0505CDP12	124	UFH-060507-MR	119
				UFH-0505CDP13	124	UFH-060507-RVSD	122

INDEX

Article number	Page	Article number	Page	Article number	Page	Article number	Page
UFH-060508-MD	119	UFH-0605MDK8	123	UFH-ISOPRO-AD11	108	V-050405-Z	95
UFH-060508-MR	119	UFH-0605MDK9	123	UFH-ISOPRO-AD30	108	V-050406-Z	95
UFH-060508-RVSD	122	UFH-0626CD01	140	UFH-MAX95	128	V-060402	95
UFH-060509-MD	119	UFH-0626CD02	140	UFH-MAXB55	128	V-060402-Z	95
UFH-060509-MR	119	UFH-0626CD03	140	UFH-M-D	119	V-060403	95
UFH-060509-RVSD	122	UFH-0626CD04	140	UFH-MDK-CON	123	V-060404	95
UFH-060510-MD	119	UFH-0626CD05	140	UFH-P18-GP10	113	V-060405	95
UFH-060510-MR	119	UFH-0626CD06	140	UFH-P18-GP18	112	V-060406	95
UFH-060510-RVSD	122	UFH-0626CD07	140	UFH-P18-GP18V	112	V-060407	95
UFH-060511-MD	119	UFH-0626CD08	140	UFH-P18-WN	113	V-060408	95
UFH-060511-MR	119	UFH-ADN10	118	UFH-PGKTA	120	V-060408-Z	95
UFH-060511-RVSD	122	UFH-ANC-05	139	UFH-PGKTA-TH	120	V-060409	95
UFH-060512-MD	119	UFH-ANC-06	139	UFH-PLUG80	116	V-070405-Z	95
UFH-060512-MR	119	UFH-A003-MZ	121	UFH-PRO	107	V-070406-Z	95
UFH-060512-RVSD	122	UFH-B0605-VN	123	UFH-PRO-ADA	108	V-070407-Z	95
UFH-0605CAF01	125	UFH-B0606-M	121	UFH-PRO-DIA	108	V-070408-Z	95
UFH-0605CAF04	125	UFH-B0606-VN	122	UFH-PRO-IND	109	V-070410-Z	95
UFH-0605CAF07	125	UFH-BEND1218	117	UFH-RAS10	109	VB050502-BLAUW	99
UFH-0605CD01	124	UFH-BEND20	117	UFH-RAS15	109	VB050502-ROOD	99
UFH-0605CD02	124	UFH-BM0606-VN	123	UFH-RAS20	109	VB050503-BLAUW	99
UFH-0605CD03	124	UFH-BS05-M	121	UFH-RAS25	110	VB050503-ROOD	99
UFH-0605CD04	124	UFH-BTM0606-M	120	UFH-RAS-BIND15A	110	VB050504-BLAUW	99
UFH-0605CD05	124	UFH-BTM0606-VN	122	UFH-RAS-BIND15B	110	VB050504-ROOD	99
UFH-0605CD06	124	UFH-C191645	129	UFH-RAS-CLIP16	110	VB060502-BLAUW	99
UFH-0605CD07	124	UFH-C191800	129	UFH-RAS-CLIP18	110	VB060502-ROOD	99
UFH-0605CD08	124	UFH-C191974	129	UFH-RAS-CLIP20	110	VB060503-BLAUW	99
UFH-0605CD09	124	UFH-C191976	129	UFH-RAS-CUT	163	VB060503-ROOD	99
UFH-0605CD10	124	UFH-C192071	129	UFH-RAS-RB3	110	VB060504-BLAUW	99
UFH-0605CD11	124	UFH-CAB-I1000	142	UFH-RAS-VLE	163	VB060504-ROOD	99
UFH-0605CD12	124	UFH-CAB-I400	142	UFH-SCOTCH-66	112	VB-EK05	98
UFH-0605CD13	124	UFH-CAB-I600	142	UFH-TACK	112	VB050502-BL	99
UFH-0605CD14	124	UFH-CAB-I800	142	UFH-TACK-38K	111	VB050502-RO	99
UFH-0605CD15	124	UFH-CAB-O1000	142	UFH-TACK-40	111	VB050503-BL	99
UFH-0605CD16	124	UFH-CAB-O400	142	UFH-TACK-60	112	VB050503-RO	99
UFH-0605CD17	124	UFH-CAB-O600	142	UFH-TACK-KLS15	111	VB050504-BL	99
UFH-0605CD18	124	UFH-CAB-O800	142	UFH-TACK-KLS20	111	VB050504-RO	99
UFH-0605CD19	124	UFH-CP	125	UFH-TACK-KLS25	111	VB060502-BL	99
UFH-0605CD20	124	UFH-DH40	117	UFH-TACK-KLS30	111	VB060502-RO	99
UFH-0605MDK02	123	UFH-DP200	117	UFH-TACK-KLS35	111	VB060503-BL	99
UFH-0605MDK03	123	UFH-DRY-B	114	UFH-TACK-ROL20	111	VB060503-RO	99
UFH-0605MDK04	123	UFH-DRY-GP100-2	113	UFH-TACK-ROL25	111	VB060504-BL	99
UFH-0605MDK05	123	UFH-DRY-VD100	114	UFH-TACK-ROL30	111	VB060504-RO	99
UFH-0605MDK06	123	UFH-ESK060303-M	121	UFH-TACK-ROL35	111	VDSK-20	64
UFH-0605MDK07	123	UFH-ESK060303-VN	122	UFH-TM050-M	121	VDSK-26	64
UFH-0605MDK08	123	UFH-FOIL50	115	UFH-TV0628	128	VEK-050502-Z	96
UFH-0605MDK09	123	UFH-FOIL90	115	UFH-UP-12	114	VEK-050502-ZV	97
UFH-0605MDK10	123	UFH-FOIL-ALU	116	UFH-UP-14	114	VEK-050504-Z	96
UFH-0605MDK10	123	UFH-FOIL-CLIP25	116	UFH-UP-14M1	114	VEK-050505-Z	96
UFH-0605MDK11	123	UFH-FOIL-N	115	UFH-UP-16	114	VEK-050506-Z	96
UFH-0605MDK11	123	UFH-GB26100	140	UFH-UP-16M1	114	VEK-050507-Z	96
UFH-0605MDK12	123	UFH-GKT	120	UFH-UP-1826M1Z	115	VEK-050508-Z	96
UFH-0605MDK12	123	UFH-H5004	139	UFH-UP-20	114	VEK-050509-Z	96
UFH-0605MDK2	123	UFH-ISO-20	107	UFH-UP-CUP50	115	VEK-060502	96
UFH-0605MDK3	123	UFH-ISOBBOARD-G	117	UFH-VLA	163	VEK-060502-Z	96
UFH-0605MDK4	123	UFH-ISOBBOARD-S	116	UFH-VLA-STR	163	VEK-060502-ZV	97
UFH-0605MDK5	123	UFH-ISODRY-25	113	UFH-VLG	163	VEK-060503	96
UFH-0605MDK6	123	UFH-ISOPRO11	107	V-050403-Z	95	VEK-060503-Z	96
UFH-0605MDK7	123	UFH-ISOPRO30	107	V-050404-Z	95	VEK-060504	96

INDEX

Article number	Page
VEK-060504-Z	96
VEK-060505	96
VEK-060505-Z	96
VEK-060506	96
VEK-060506-Z	96
VEK-060507	96
VEK-060507-Z	96
VEK-060508	96
VEK-060508-Z	96
VEK-060509	96
VEK-060509-Z	96
VEK-060510	96
VEK-060510-Z	96
VISION SET 16	60
VISION SET 20	60
VISION SET 26	60
VISION-KEY16	60
VISION-KEY20	60
VISION-KEY26	60
VR-EK05	98
VS-05	98
VS-0504	98
VS-06	98
VS-0604	98
VS-0605	98
VS-07	98
VS-ENDCAP	63
VS-ENDCAP-M	64
VSK-1616	61
VSK-161616	61
VSKEK-0502	61
VSKEK-0503	61
VVSK-20	62
VVSK-20-90	63
VVSK-26	62
VVSK-26-90	63
VVSK-T202020	63
VVSK-T20M20	62
VVSK-T262626	63
VVSK-T26M26	62
WBP-1604	80
WBP-2004	80
WBS-1604	93

WE CARE TO CONNECT



Henco Industries NV | Toekomstlaan 27, 2200 Herentals | Tel. +32 14 28 56 60 | www.henco.be

Technische veranderingen en drukfouten voorbehouden

Technical amendments and printing errors reserved

Changements techniques et fautes d'impression sous réserve

Technische Änderungen und Druckfehler vorbehalten